

# CRS-2000

## 2000W SINGLE OUTPUT DC/DC CONVERTERS

### GENERAL FEATURES:

- Designed according to EN50155
- Fire and smoke: EN45545-2
- High input-output isolation
- Adjustable output voltage
- Remote inhibit
- Remote sensing
- Input & Output OK LEDs
- Output failure alarm
- Input reverse polarity protection
- ORing FET option
- Efficiency up to 93%



	24Vin 14.4V ... 33.6V	36Vin 21.6V ... 50.4V	48Vin 28.8V ... 67.2V	72Vin 43.2V ... 100.8V	110Vin 66V ... 154V
24Vout	<b>CRS-2000-6951*</b>	<b>CRS-2000-6955*</b>	<b>CRS-2000-6959*</b>	<b>CRS-2000-6963</b>	<b>CRS-2000-6967*</b>
48Vout	<b>CRS-2000-6952*</b>	<b>CRS-2000-6956*</b>	<b>CRS-2000-6960*</b>	<b>CRS-2000-6964*</b>	<b>CRS-2000-6968*</b>
72Vout	<b>CRS-2000-6953</b>	<b>CRS-2000-6957*</b>	Available under request*	Available under request*	Available under request*
110Vout	<b>CRS-2000-6954</b>	Available under request*	Available under request*	Available under request*	<b>CRS-2000-6970*</b>

\*References subject to special MOQs and lead times



<b>INPUT</b>	
Input voltage range	See table
Input undervoltage shutdown	55% to 60% Vi nom
Maximum allowed input ripple	5% Vin nom (EN50155)
<b>OUTPUT</b>	
Output voltage	See table
Output voltage adjustment:	
Vi min = 60% Vi nom	-10% ... +0% Vo nom
Vi min = 70% Vi nom	-10% ... +15% Vo nom
Line regulation (Io = nom)	< 0.2 %
Load regulation (Vin = nom, Io: 0...100%)	< 0.2 %
Ripple and noise (BW: 20MHz)	< 100 mVpp (Ta: -25°C ... 70°C) < 150 mVpp (Ta: -40°C ... -25°C)
Max. overvoltage protection	< 140% Vout nom
Max. overcurrent protection	105-110% Iout nom
Maximum remote sense	0.3V / pole
<b>ENVIRONMENTAL</b>	
Storage temperature	-40°C ... 85°C
Operating temperature range Io: 100%	-25°C ... 55°C (-40°C ... 55°C, see note-1)
Operating temperature range Io: 62.5%	-25°C ... 70°C (-40°C ... 70°C, see note-1)
Cooling	Internal forced air controlled
Maximum Relative humidity	95% with no condensation
Shock and vibration	EN61373 Category 1 class B body mounted with accessory NP-9282
MTBF	250.000h @ 40°C according to IEC61709
Service life (at 40°C and 75% load)	20 years (fan maintenance after 10 years is required)
<b>EMC</b>	
Emission according to	EN50121-3-2, EN50121-4, EN61000-6-4, see note-2
Immunity according to	EN50121-3-2, EN50121-4, EN61000-6-2, see note-2
<b>SAFETY</b>	
Safety according to	EN62368-1, EN60950-1
Dielectric strength Input-Output	3000Vac, 4200Vdc 1min.
Dielectric strength Input-Earth	1500Vac, 2100Vdc 1min.
Dielectric strength Output-Earth	1500Vac, 2100Vdc 1min.
Fire and smoke	EN45545-2
<b>MECHANICAL</b>	
Approximate weight	<6kg
<b>CONTROL</b>	
Remote inhibit range	Logic: 1=OFF, Range: Vin
Alarm contacts	1A @ 24Vdc, 0.3A @ 150Vdc, 0.5A @ 125Vac
Local: Input OK, Output OK	Green LEDs
<b>PROTECTIONS</b>	
Against overloads and short-circuits	Current limiting
Against output over-voltages	Shutdown (reset by input switch off)
Against over-temperature	Shutdown with self-recovery
Against reverse input voltage	Input fuse (Active protection with option H)
Against input under-voltage	Under-voltage lock-out
Against input over-voltage	Over-voltage lock-out



Against input over-currents

Input fuse

Note-1: Below -25°C, handling the signals connector is not recommended.

Note-2: The emissions and immunity standard that the product meets depend on its part number (CRS-2000-69XX**S-or-Z**XX).

## ORDERING CODES

Part Number	Output Power [W]	Input Voltage [V]	Input Voltage Range [V]	Output Voltage [V]	Output Current [A]	Efficiency [%]
CRS-2000-6951*	2000	24	14.4 - 33.6	24	83.3	88
CRS-2000-6952*	2000	24	14.4 - 33.6	48	41.7	89
CRS-2000-6953	2000	24	14.4 - 33.6	72	27.8	90
CRS-2000-6954	2000	24	14.4 - 33.6	110	18.2	91
CRS-2000-6955*	2000	36	21.6 - 50.4	24	83.3	90
CRS-2000-6956*	2000	36	21.6 - 50.4	48	41.7	90
CRS-2000-6959*	2000	48	28.8 - 67.2	24	83.3	91
CRS-2000-6960*	2000	48	28.8 - 67.2	48	41.7	92
CRS-2000-6963	2000	72	43.2 - 100.8	24	83.3	91
CRS-2000-6964*	2000	72	43.2 - 100.8	48	41.7	92
CRS-2000-6967*	2000	110	66 - 154	24	83.3	92
CRS-2000-6968*	2000	110	66 - 154	48	41.7	93

\*References subject to special MOQs and lead times

## CRS – 2000 – 69

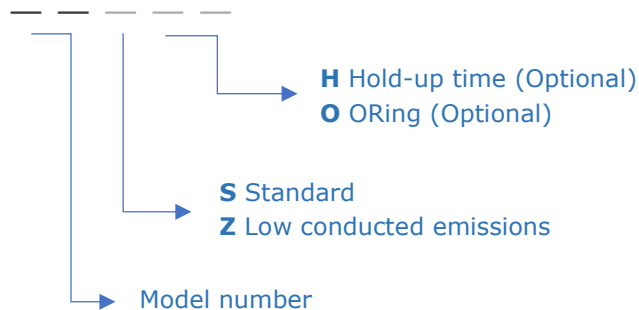

OPTIONS INFORMATION	Letter code
EMC according to EN50121-3-2, EN61000-6-4	<b>S</b>
EMC according to EN50121-4, EN50121-3-2, EN61000-6-4	<b>Z</b>
Hold up time of 10ms at 2000W. Includes: <ul style="list-style-type: none"> <li>Active protection against input reverse polarity</li> <li>Active inrush current limiter at <math>&lt; 2 \cdot I_{in\ max}</math> (Maximum Input current)</li> </ul>	<b>H</b>
ORing FET for redundancy. Includes a passive current sharing by voltage drop $< 2.5\%$	<b>O</b>

Accessories must be ordered in a separate order line.



## BLOCKS DIAGRAM

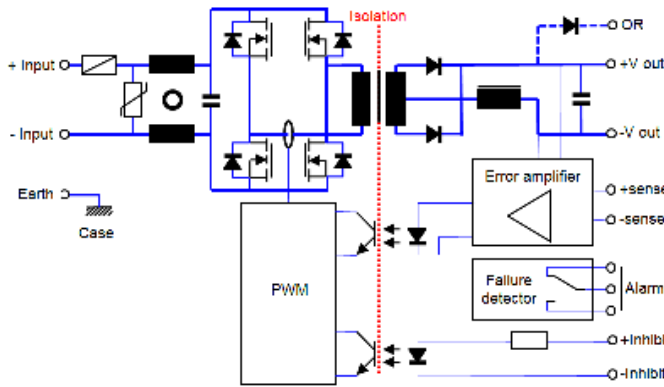

## DESCRIPTION

The CRS-2000 series consists of DC-DC converters with galvanic isolation between input and output. The converters operate at a fixed switching frequency and use full-bridge converter topology.

For optimum regulation, remote sensing terminals must be connected on the load allowing to compensate for a voltage drop up to 0.3V on each cable.

A current limiting circuit protects the PSU against overloads and short-circuits.

The device is also protected against reverse polarity on input and the input fuse blows if an improper connection is made.

Under input undervoltage condition the PSU is disabled to prevent excessive discharge on the battery.

## CONNECTIONS

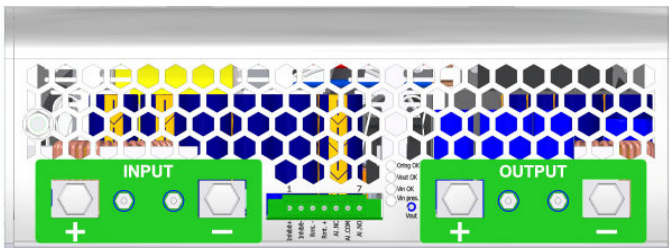

### Power connections (input and output)

Terminal blocks up to 50mm<sup>2</sup>

Earth: M5 Threaded stud

### Signals connector

1	+ Inhibit
2	- Inhibit
3	- Remote sense
4	+ Remote sense
5	Alarm relay NC (closed when alarm)
6	Alarm relay Common
7	Alarm relay NO (open when alarm)

## TYPICAL OUTPUT CHARACTERISTIC

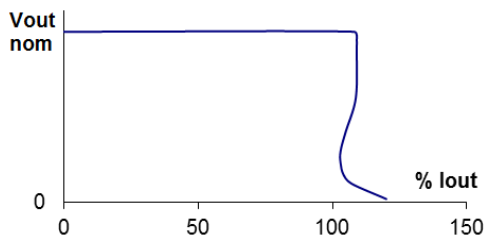

## POWER DERATING vs AMBIENT TEMP.

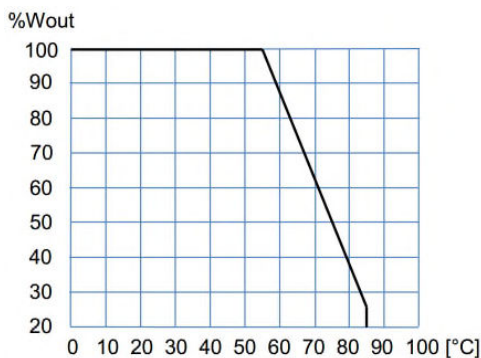

## START-UP

Cable connection should follow power and signal connection figures. Remote sensing is not mandatory, but if it is required, use of a co-axial or a twisted-pair cable is recommended.

**WARNING:** If the load is connected to the tabs of remote sensing (+/-S) and the connection from the output to this load is missing the remote sensing function could be made unusable due to the acting of the internal fuse protection.

If power levels close to the maximum are required, make sure the assembly enhances cooling by natural convection and the unit is placed in vertical position.

If several converters need to be paralleled, do as follows:

- Adjust output voltages of paralleled PSUs till they values match.
- Join the load outputs by using cables with a cross-section no greater than the one required and of equal length.
- Connect both output loads using cable with proper cross-section area and equal length.
- Do not use remote sensing.

For safety reasons, the following requirements must be complied:

- Provide the equipment with a protective enclosure that complies with the electrical safety directives in effect within the country where the equipment is installed.
- Only replace the fuse with another fuse of the same rating and type, and only after disconnecting the converter from DC power.

## INSTALLATION

There are two installation options available. Installation using the screw holes at the bottom of the enclosure or installation on a chassis by means of the optional mounting brackets.

The inlet and outlet air must be free of elements that cause an airflow reduction (the minimum recommended distance to other objects is 50mm).

It is necessary to consider the environmental conditions of maximum temperature and altitude since they can limit the maximum output power.

## WORKING PARAMETERS

Input voltage parameters	24V	36V	48V	72V	110V
High input voltage instantaneous shutdown	34.1V	51.1V	68.2V	102.2V	156.2V
High input voltage timed shutdown (t >100ms) (Full load)	31.9V	47.9V	63.8V	95.8V	146.3V
Start-up voltage	18.5V	27.7V	37.0V	55.4V	84.7V
Low input voltage timed shutdown (t >100ms) (Full load)	16.1V	24.1V	32.2V	48.2V	73.7V
Low input voltage instantaneous shutdown	13.9V	20.9V	27.8V	41.8V	63.8V

## DIMENSIONS

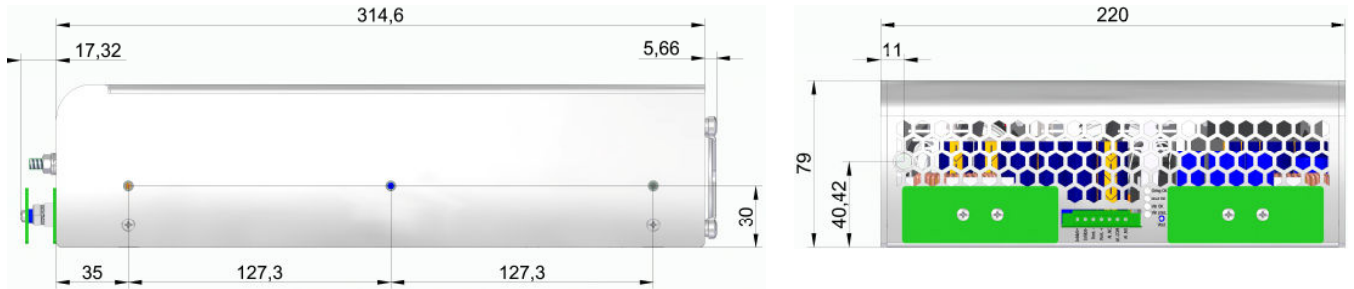

## ACCESSORIES

Description	Notes	CODE
Signals mating connector	Phoenix Contact FK-MCP 1,5/ 7-STF-3,81	2601-395
Mounting brackets kit	Contains two brackets and screws	NP-9449

**2601-395**



**NP-9449**

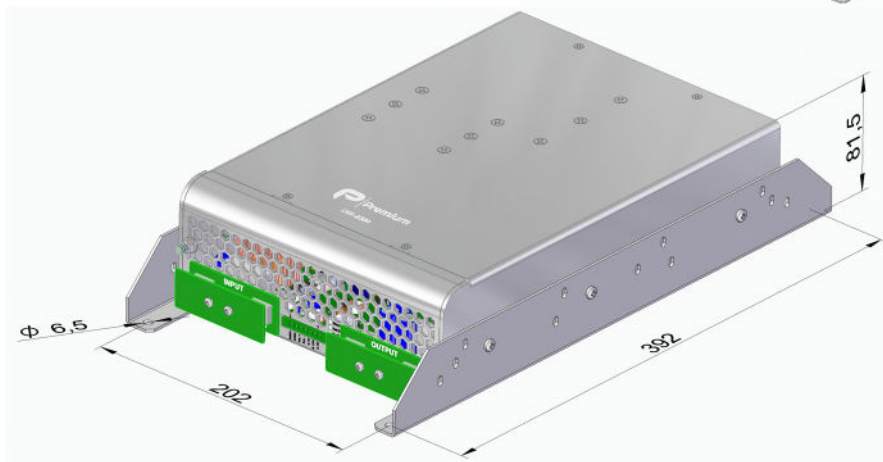



## CE|UK CA EU, UKCA DECLARATION OF CONFORMITY

The undersigned, representing the following:

Manufacturer: PREMIUM, S. A.,  
Address: C/ Dolors Aleu 19-21, 08908 L'Hospitalet de Llobregat, SPAIN

herewith declares that the product:

Type: DC/DC converter  
Models: **CRS-2000-6951 ... 6968**

is in conformity with the provisions of the following EU directives and UK legislation:

2014/35/EU SI 2016 No 1101	Low voltage / The electrical equipment (safety) regulations
2014/30/EU SI 2016 No 1091	EMC / Electromagnetic compatibility regulations
2015/863/EU SI 2012 No. 3032	RoHS / Restriction of the use of certain hazardous substances in electrical and electronic equipment

and that standards and/or technical specifications referenced below have been applied:

EN 60950-1: 2005	Safety. Information technology equipment
EN 62368-1: 2014	Safety. Audio/video, information and communication technology equipment
EN 61000-6-4: 2007	Generic emission standard
EN 61000-6-2: 2005	Generic immunity standard
EN 50155: 2017*	Railway applications. Electronic equipment used on rolling stock material
EN 50121-3-2: 2016* IEC 62236-3-2: 2018*	Railway applications. EMC Rolling stock equipment
EN 50121-4: 2016* IEC 62236-4: 2018*	Railway applications. EMC of the signalling and telecommunications apparatus

\* See annexe

CE marking year: **2021**; UKCA marking year: **2021**

### Notes:

For the fulfillment of this declaration the product must be used only for the aim that has been conceived, considering the limitations established in the instructions manual or datasheet.

L'Hospitalet de Llobregat, 21-10-2021

Albert Sole  
Technical Director

**PREMIUM S.A.** is an ISO9001 and ISO14001  
certified company by **Bureau Veritas**

## ANNEXE

Applicable values for the different sections of the norm EN50155:2017																																																																		
4.3.1	Working altitude	Up to 2000m																																																																
4.3.2	Ambient temperature	Class OT1 (-25 to 55°C): load < 100% Class OT2 (-40 to 55°C): load < 100% (Without connectors handling and output ripple <150mVpp) Class OT3 (-25 to 70°C): load < 62.5% Class OT4 (-40 to 70°C): load < 62.5% (Without Connectors handling and output ripple <150mVpp) Class OT5 (-25 to 85°C): load < 25% Class OT6 (-40 to 85°C): load < 25% (Without Connectors handling and output ripple <150mVpp)																																																																
4.3.3	Switch-on extended operating temp.	ST1																																																																
4.3.4	Rapid temperature variations	H1																																																																
4.3.5	Shocks and vibrations	According EN61373:2010 Category 1 class B																																																																
4.3.6	EMC Electromagnetic Compatibility  EN50121-3-2:2016 IEC 62236-3-2: 2018 EN50121-4:2016 IEC 62236-4: 2018	<table border="1"> <thead> <tr> <th>Test</th> <th>Norm</th> <th>Port</th> <th>Frequency</th> <th>Limits</th> </tr> </thead> <tbody> <tr> <td rowspan="4">Radiated emissions</td> <td rowspan="4">IEC55016</td> <td rowspan="4">Case</td> <td>30MHz...230MHz</td> <td>40dB(µV/m) Qpk at 10m</td> </tr> <tr> <td>230MHz...1GHz</td> <td>47dB(µV/m) Qpk at 10m</td> </tr> <tr> <td>1...3GHz</td> <td>Do not apply</td> </tr> <tr> <td>3...6GHz</td> <td>Internal freq. &lt; 108MHz</td> </tr> <tr> <td rowspan="2">Conducted emissions</td> <td rowspan="2">IEC55016</td> <td rowspan="2">Input</td> <td>150kHz...500kHz</td> <td>EN50121-3-2: 99dB(µV) Qpk EN50121-4: 79dB(µV) Qpk, 66dB(µV) Av</td> </tr> <tr> <td>500kHz...30MHz</td> <td>EN50121-3-2: 93dB(µV) Qpk EN50121-4: 73dB(µV) Qpk, 60dB(µV) Av</td> </tr> </tbody> </table>	Test	Norm	Port	Frequency	Limits	Radiated emissions	IEC55016	Case	30MHz...230MHz	40dB(µV/m) Qpk at 10m	230MHz...1GHz	47dB(µV/m) Qpk at 10m	1...3GHz	Do not apply	3...6GHz	Internal freq. < 108MHz	Conducted emissions	IEC55016	Input	150kHz...500kHz	EN50121-3-2: 99dB(µV) Qpk EN50121-4: 79dB(µV) Qpk, 66dB(µV) Av	500kHz...30MHz	EN50121-3-2: 93dB(µV) Qpk EN50121-4: 73dB(µV) Qpk, 60dB(µV) Av																																									
		Test	Norm	Port	Frequency	Limits																																																												
		Radiated emissions	IEC55016	Case	30MHz...230MHz	40dB(µV/m) Qpk at 10m																																																												
					230MHz...1GHz	47dB(µV/m) Qpk at 10m																																																												
					1...3GHz	Do not apply																																																												
					3...6GHz	Internal freq. < 108MHz																																																												
		Conducted emissions	IEC55016	Input	150kHz...500kHz	EN50121-3-2: 99dB(µV) Qpk EN50121-4: 79dB(µV) Qpk, 66dB(µV) Av																																																												
					500kHz...30MHz	EN50121-3-2: 93dB(µV) Qpk EN50121-4: 73dB(µV) Qpk, 60dB(µV) Av																																																												
		<table border="1"> <thead> <tr> <th>Test</th> <th>Norm</th> <th>Port</th> <th>Severity</th> <th>Conditions</th> <th>P</th> </tr> </thead> <tbody> <tr> <td rowspan="2">Electrostatic discharge</td> <td rowspan="2">IEC61000-4-2</td> <td rowspan="2">Case</td> <td>±8kV</td> <td>Air (isolated parts)</td> <td rowspan="2">B</td> </tr> <tr> <td>±8kV</td> <td>Contact (conductive parts)</td> </tr> <tr> <td rowspan="4">Radiated high-frequency</td> <td rowspan="4">IEC61000-4-3</td> <td rowspan="4">X/Y/Z Axis</td> <td>20V/m</td> <td>0.08...1.0GHz M. 80% 1kHz</td> <td rowspan="4">A</td> </tr> <tr> <td>10V/m</td> <td>1.4...2.1GHz M. 80% 1kHz</td> </tr> <tr> <td>5V/m</td> <td>2.1...2.5GHz M. 80% 1kHz</td> </tr> <tr> <td>3V/m</td> <td>5.1...6GHz M. 80% 1kHz</td> </tr> <tr> <td rowspan="4">Fast transients</td> <td rowspan="4">IEC61000-4-4</td> <td>Input</td> <td>±2kV</td> <td rowspan="4">Tr/Th: 5/50 ns</td> <td rowspan="4">A</td> </tr> <tr> <td>Output</td> <td>±2kV</td> </tr> <tr> <td>Signal</td> <td>±2kV</td> </tr> <tr> <td>PE</td> <td>±1kV</td> </tr> <tr> <td rowspan="2">Surge</td> <td rowspan="2">IEC61000-4-5</td> <td>Input L to L</td> <td>±1kV</td> <td rowspan="2">Tr/Th: 1.2/50µs</td> <td rowspan="2">B</td> </tr> <tr> <td>Input L to PE</td> <td>±2kV</td> </tr> <tr> <td rowspan="4">Conducted RF</td> <td rowspan="4">IEC61000-4-6</td> <td>Input</td> <td>10V</td> <td rowspan="4">0.15...80MHz M. 80% 1kHz</td> <td rowspan="4">A</td> </tr> <tr> <td>Output</td> <td>10V</td> </tr> <tr> <td>Signal</td> <td>10V</td> </tr> <tr> <td>PE</td> <td>10V</td> </tr> <tr> <td>Magnetic field</td> <td>IEC61000-4-8</td> <td>X/Y/Z Axis</td> <td>300A/m</td> <td>0Hz, 16.7Hz, 50/60Hz</td> <td>A</td> </tr> </tbody> </table>	Test	Norm	Port	Severity	Conditions	P	Electrostatic discharge	IEC61000-4-2	Case	±8kV	Air (isolated parts)	B	±8kV	Contact (conductive parts)	Radiated high-frequency	IEC61000-4-3	X/Y/Z Axis	20V/m	0.08...1.0GHz M. 80% 1kHz	A	10V/m	1.4...2.1GHz M. 80% 1kHz	5V/m	2.1...2.5GHz M. 80% 1kHz	3V/m	5.1...6GHz M. 80% 1kHz	Fast transients	IEC61000-4-4	Input	±2kV	Tr/Th: 5/50 ns	A	Output	±2kV	Signal	±2kV	PE	±1kV	Surge	IEC61000-4-5	Input L to L	±1kV	Tr/Th: 1.2/50µs	B	Input L to PE	±2kV	Conducted RF	IEC61000-4-6	Input	10V	0.15...80MHz M. 80% 1kHz	A	Output	10V	Signal	10V	PE	10V	Magnetic field	IEC61000-4-8	X/Y/Z Axis	300A/m	0Hz, 16.7Hz, 50/60Hz	A
		Test	Norm	Port	Severity	Conditions	P																																																											
Electrostatic discharge	IEC61000-4-2	Case	±8kV	Air (isolated parts)	B																																																													
			±8kV	Contact (conductive parts)																																																														
Radiated high-frequency	IEC61000-4-3	X/Y/Z Axis	20V/m	0.08...1.0GHz M. 80% 1kHz	A																																																													
			10V/m	1.4...2.1GHz M. 80% 1kHz																																																														
			5V/m	2.1...2.5GHz M. 80% 1kHz																																																														
			3V/m	5.1...6GHz M. 80% 1kHz																																																														
Fast transients	IEC61000-4-4	Input	±2kV	Tr/Th: 5/50 ns	A																																																													
		Output	±2kV																																																															
		Signal	±2kV																																																															
		PE	±1kV																																																															
Surge	IEC61000-4-5	Input L to L	±1kV	Tr/Th: 1.2/50µs	B																																																													
		Input L to PE	±2kV																																																															
Conducted RF	IEC61000-4-6	Input	10V	0.15...80MHz M. 80% 1kHz	A																																																													
		Output	10V																																																															
		Signal	10V																																																															
		PE	10V																																																															
Magnetic field	IEC61000-4-8	X/Y/Z Axis	300A/m	0Hz, 16.7Hz, 50/60Hz	A																																																													
		<b>P</b> = Performance criteria, L= Line, PE= Protective Earth																																																																
4.3.7	Relative humidity	Up to 95%																																																																
5.1.1.2	DC power supply range	From 0.70 to 1.25 Un continuous																																																																
5.1.1.3	Temporary DC power supply fluctuation	From 0.60 to 1.40 Un 0.1s From 1.25 to 1.40 Un 1s without damage																																																																
5.1.1.4	Interruptions of voltage supply	Class S2																																																																
5.1.1.6	Input ripple factor	10% peak to peak with a DC Ripple Factor of 5 %																																																																
5.1.3	Supply change-over	0.6 Un duration 100ms (without interruptions). Performance criterion A																																																																
7.2.7	Input reverse polarity protection	By fuse																																																																
10.7	Protective coating for PCB assemblies	Class PC2																																																																
13.3	Tests list	1 Visual Inspection 2 Performance test 3 Power supply test 4 Insulation test 5 Low temperature storage test 6 Low temperature start-up test 7 Dry heat test 8 Cyclic damp heat test 9 Salt mist test 10 Enclosure protection test (IP code) 11 EMC test 12 Shocks and vibrations test 13 Equipment stress screening test 14 Rapid Temperature variation test	Routine Routine Routine Routine - Type Type Type - - Type Type Routine: 24h at 40°C and load 100% Type																																																															