



# CHASSIS MOUNT CHB200W12-72S CMFD Series Application Note V10

## ISOLATED DC-DC CONVERTER CHASSIS MOUNT CHB200W12-72S CMFD SERIES APPLICATION NOTE



**Approved By:**

Department	Approved By	Checked By	Written By
Research and Development Department	Jacky	Astray	Joe
Design Quality Department	Benny	JoJo	



# CHASSIS MOUNT CHB200W12-72S CMFD Series Application Note V10

## Contents

1. Introduction .....	3
2. Pin Function Description .....	3
3. Terminal Block .....	4
4. Connection for standard use .....	5
5. Test Set-Up .....	5
6. Features and Functions .....	6
6.1 UVLO (Under Voltage Lock Out) .....	6
6.2 Over Current/Short Circuit Protection .....	6
6.3 Output Over Voltage Protection .....	6
6.4 Over Temperature Protection .....	6
6.5 Remote On/Off .....	7
6.6 Output Remote Sensing .....	7
6.7 Output Voltage Adjustment .....	8
7. Input / Output Considerations .....	8
7.1 Hold up Time .....	8
7.2 Output Ripple and Noise .....	9
7.3 Output Capacitance .....	9
8. Series and Parallel Operation .....	10
8.1 Series Operation .....	10
8.2 Parallel Operation .....	10
8.3 Redundant Operation .....	10
9. Thermal Design .....	11
9.1 Operating Temperature Range .....	11
9.2 Convection Requirements for Cooling .....	11
9.3 Thermal Considerations .....	11
9.4 Power Derating .....	11
9.5 Heat Sink .....	14
10. Safety & EMC .....	14
10.1 Input Fusing and Safety Considerations .....	14
10.2 EMC Considerations .....	14



# CHASSIS MOUNT CHB200W12-72S CMFD Series

## Application Note V10

### 1. Introduction

The CHB200W12-72SXX-CMFD series of chassis mountable DC-DC converters offers 200 watts of output power @ single output voltages of 12, 15, 24, 48VDC. It has a wide (12:1) input voltage range of 14 to 160VDC (72VDC nominal) and 3000VAC basic isolation.

High efficiency up to 89.5%, allowing case operating temperature range of -40°C to 95°C. An external heatsink is required to expand the full power range of the product. Low no load power consumption (50mA), an ideal solution for energy critical systems.

Built-in EMI EN 50155, EN 50121-3-2 filter. Meet EN 45545-2. The standard control functions include remote **on/off** (positive or negative) and +15%, -15% adjustable output voltage.

Fully protected against input UVLO (under voltage lock out), output over-current, output over-voltage and over-temperature and continuous short circuit conditions.

CHB200W12-72SXX-CMFD series is designed primarily for common railway applications of 24V, 36V, 48V, 72V, 96V, 110V nominal voltage and also suitable for distributed power architectures, telecommunications, battery operated equipment and industrial applications.

### 2. Pin Function Description

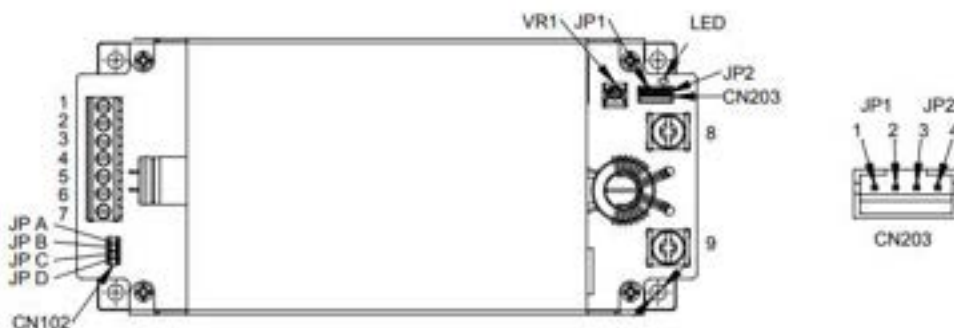

No	CN1&CN2	Description	Reference
1	Case	Connected to Base Plate	
2	Remote	External Remote On/Off Control	<b>Section 6.5</b>
3	BUS	Pre-Regulator Voltage Output	<b>Section 7.1</b>
4	-V Input	Negative Supply Input	<b>Section 7.1</b>
5	-V Input	Negative Supply Input	<b>Section 7.1</b>
6	+V Input	Positive Power Output	<b>Section 7.1</b>
7	+V Input	Positive Power Output	<b>Section 7.1</b>
8	-V Output	Negative Power Output	<b>Section 7.2/7.3</b>
9	+V Output	Positive Power Output	<b>Section 7.2/7.3</b>
--	--	Clear Mounting Insert (FG)	<b>Section 9.5</b>

No	CN102	Description	Reference
JP A	UVLO Set up	UVLO Threshold Adjust (VIN=36V)	<b>Section 6.1</b>
JP B	UVLO Set up	UVLO Threshold Adjust (VIN=48V)	<b>Section 6.1</b>
JP C	UVLO Set up	UVLO Threshold Adjust (VIN=72V)	<b>Section 6.1</b>
JP D	UVLO Set up	UVLO Threshold Adjust (VIN=110V)	<b>Section 6.1</b>



# CHASSIS MOUNT CHB200W12-72S CMFD Series

## Application Note V10

No	CN203	Description	Reference
1	-V Output	Negative Output Remote Sense	<b>Section 7.2/7.3</b>
2	-Sense	Negative Power Output	<b>Section 6.6</b>
3	+Sense	Positive Output Remote Sense	<b>Section 6.6</b>
4	+V Output	Positive Power Output	<b>Section 7.2/7.3</b>

Note: Base plate can be connected to FG through  $\varnothing 4.5$  mounting insert. Recommended torque 9.6~12.8Kgf-cm.

### 3. Terminal Block

Input and Output Terminal Block

PIN	Terminal Type	Recommended Screw Torque Value (Kgf-cm)	Suitable Electric Wire (AWG)	Current Rating (max.)
1~7	EK500V-07P or Equivalent	5	12-24	20A
8~9	M5 Terminal Screw	20.4	4(max)	85A



# CHASSIS MOUNT CHB200W12-72S CMFD Series Application Note V10

## 4. Connection for standard use

The connection for standard use is shown below. An external output capacitor (C1) is recommended to reduce output ripple and noise, output capacitor recommended 1 uF ceramic capacitor.

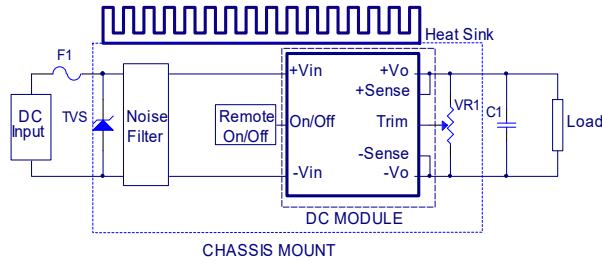

Symbol	Component	Reference
F1	Input fuse	<b>Section 10.1</b>
Noise Filter	Internal input noise filter	<b>Section 10.2</b>
Remote On/Off	External Remote On/Off control	<b>Section 6.5</b>
Trim	Internal output voltage adjustment by variable resistor	<b>Section 6.7</b>
Heat sink	External heat sink	<b>Section 9.4/9.5</b>
+Sense/-Sense	--	<b>Section 6.6</b>

## 5. Test Set-Up

The basic test set-up to measure parameters such as efficiency and load regulation is shown below. When testing the modules under any transient conditions please ensure that the transient response of the source is sufficient to power the equipment under test. We can calculate:

- Efficiency
- Load regulation and line regulation

The value of efficiency is defined as:

$$\eta = \frac{V_o \times I_o}{V_{in} \times I_{in}} \times 100\%$$

Where:

- $V_o$  is output voltage,
- $I_o$  is output current,
- $V_{in}$  is input voltage,
- $I_{in}$  is input current.

The value of load regulation is defined as:

$$Load.reg = \frac{V_{FL} - V_{NL}}{V_{NL}} \times 100\%$$

Where:

$V_{FL}$  is the output voltage at full load

$V_{NL}$  is the output voltage at no load

The value of line regulation is defined as:

$$Line.reg = \frac{V_{HL} - V_{LL}}{V_{LL}} \times 100\%$$

Where:

$V_{HL}$  is the output voltage of maximum input voltage at full load

$V_{LL}$  is the output voltage of minimum input voltage at full load

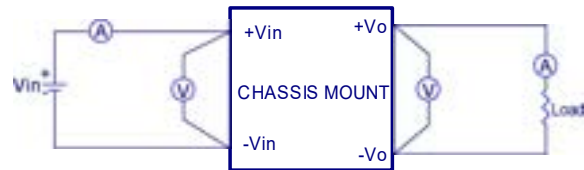

**CHB200W12-72SXX-CMFD Series Test Setup**



# CHASSIS MOUNT CHB200W12-72S CMFD Series Application Note V10

## 6. Features and Functions

### 6.1 UVLO (Under Voltage Lock Out)

Input under voltage lockout is standard on the CHB200W12-72SXX-CMFD unit. The unit will shut down when the input voltage drops below a threshold, and the unit will operate when the input voltage goes above the upper threshold.

**CHB200W12-72SXX-CMFD  
Iin Vs Vin**

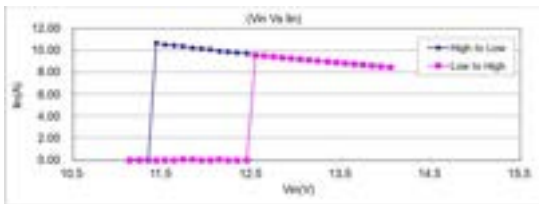

And the CHB200W12-72S-CMFD series has an(CN102) adjustable under voltage lockout which will shut down the converter according to following settings.

Nom. Input Voltage (Vdc)	24	36	48	72	110
Turn Off Threshold (Vdc)	11.0±0.5	20.0±1.0	27.3±1.0	41.6±1.0	53.0±1.0
Turn On Threshold (Vdc)	13.0±0.5	22.0±1.0	29.6±1.0	44.6±1.0	58.0±1.0
CN102 Setting					
JPA	Open	Short	Open	Open	Open
JP B	Open	Open	Short	Open	Open
JP C	Open	Open	Open	Short	Open
JP D	Open	Open	Open	Open	Short

### 6.2 Over Current/Short Circuit Protection

All models have internal over current and continuous short circuit protection. The unit operates normally once the fault condition is removed. At the point of current limit inception, the converter will go into hiccup mode protection.

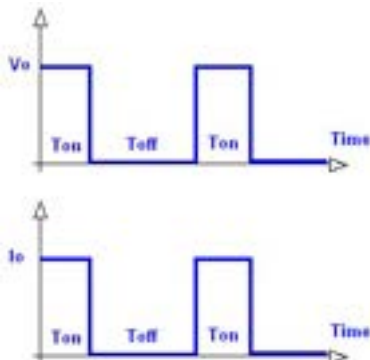

### 6.3 Output Over Voltage Protection

The output over voltage protection consists of circuitry that internally limits the output voltage. If more accurate output over voltage protection is required, then an external circuit can be used via the remote on/off pin.

**Note:** Please note that device inside the power supply might fail when voltage more than rate output voltage is applied to output pin. This could happen when the customer tests the over voltage protection of unit.

### 6.4 Over Temperature Protection

These modules have an over temperature protection circuit to safeguard against thermal damage. Shutdown occurs with the maximum case reference temperature is exceeded. The module will restart when the case temperature falls below over temperature recovery threshold. Please measure case temperature of the center part of aluminum base plate.

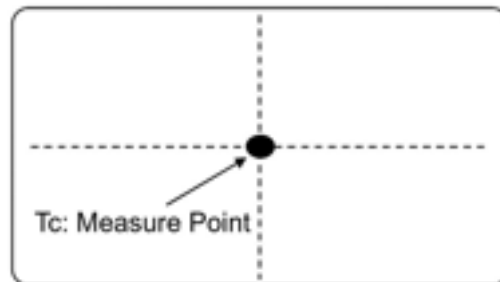
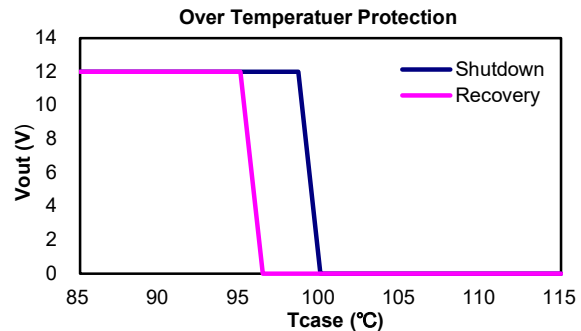



# CHASSIS MOUNT CHB200W12-72S CMFD Series

## Application Note V10

### 6.5 Remote On/Off

The CHB200W12-72SXX-CMFD series allows the user to switch the module on and off electronically with the remote **on/off** feature. All models are available in “positive logic” and “negative logic” (optional) versions. The converter turns on if the remote **on/off** pin is high (>3.5Vdc to 160Vdc or open circuit). Setting the pin low (0 to <1.2Vdc) will turn the converter off. The signal level of the remote on/off input is defined with respect to ground.

If not using the remote **on/off** pin, leave the pin open (converter will be on).

Models with part number suffix “N” are the “negative logic” remote **on/off** version. The unit turns off if the remote **on/off** pin is high (>3.5Vdc to 160Vdc or open circuit). The converter turns on if the on/off pin input is low (0 to <1.2Vdc). Note that the converter is off by default.

Logic State (Pin 2)	Negative Logic	Positive Logic
Logic Low – Switch Closed	Module on	Module off
Logic High – Switch Open	Module off	Module on

The converter remote **on/off** circuit built-in on input side. The ground pin of input side remote **on/off** circuit is -Vin pin.

Connection examples see below.

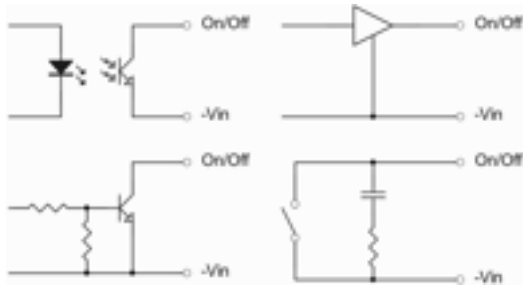

Remote On/Off Connection Example

### 6.6 Output Remote Sensing

The CHB200W12-72SXX-CMFD series converter has the capability to remotely sense both lines of its output. This feature moves the effective output voltage regulation point from the output of the unit to the point of connection of the remote sense pins. This feature automatically adjusts the real output voltage of the CHB200W12-72SXX-CMFD series in order to compensate for voltage drops in distribution and maintain a regulated voltage at the point of load. The remote -sense voltage range is:

$$[(+V_{out}) - (-V_{out})] - [(+Sense) - (-Sense)] \leq 15\% \text{ of } V_{o\_nominal}$$

When remote sensing is used, please remove the jumper of CN203. When remote sense is in use, the sense should be connected by twisted-pair wire or shield wire. If the sensing patterns short, heavy current flows and the pattern may be damaged. Output voltage might become unstable because of impedance of wiring and load condition when length of wire is exceeding 400mm. This is shown in the schematic below.

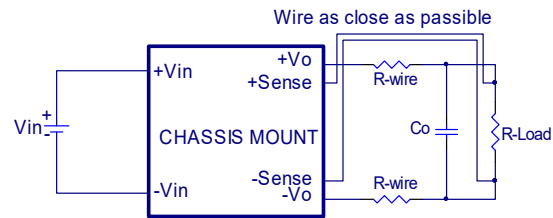

When the CHB200W-72SXX-CMFD module are shipped from a factory, they come with a dedicated jumper being mounted on CN203. If the remote sense feature is not to be used, the sense pins should be connected locally. The +Sense pin should be connected to the +V<sub>out</sub> pin at the module and the -Sense pin should be connected to the -V<sub>out</sub> pin at the module. Wire between +Sense and +V<sub>out</sub> and between -Sense and -V<sub>out</sub> as short as possible. Loop wiring should be avoided. The converter might become unstable by noise coming from poor wiring. This is shown in the schematic below.

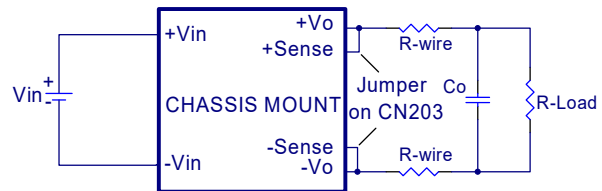

**Note:**

Although the output voltage can be varied (increased or decreased) by both remote sense and trim, the maximum variation for the output voltage is the larger of the two values not the sum of the values. The output power delivered by the module is defined as the voltage at the output terminals multiplied by the output current. Using remote sense and trim can cause the output voltage to increase and consequently increase the power output of the module if output current remains unchanged. Always ensure that the output power of the module remains at or below the maximum rated power. Also be aware that if V<sub>o,set</sub> is below nominal value, P<sub>out,max</sub> will also decrease accordingly because I<sub>o,max</sub> is an absolute limit. Thus, P<sub>out,max</sub> = V<sub>o,set</sub> X I<sub>o,max</sub> is also an absolute limit.



# CHASSIS MOUNT CHB200W12-72S CMFD Series Application Note V10

## 6.7 Output Voltage Adjustment

Output voltage can be adjusted by internal variable resistor (adjustment range: +15% to -15% of nominal output). Turning internal variable resistor clockwise reduces the output voltage and counterclockwise increases the output voltage.

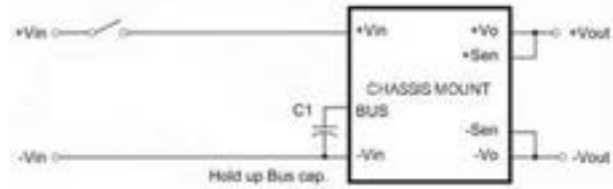
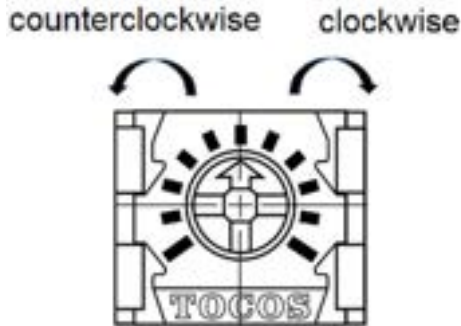

$V_{in}$ \ C1	24V	36V	48V	72V	96V	110V
For 10 mS	2000uF	2000uF	2000uF	2000uF	220uF	NC
For 30 mS	6800uF	6800uF	6800uF	6800uF	2000uF	940uF

The BUS voltage and input voltage curve is shown as below. The red curve, BUS keeps stable at 73V when input voltage rise from 14V to 73V, when the input voltage is above 73V, then BUS follows input voltage. The blue curve, BUS falls with input voltage until the input voltage falls to 70V, then BUS will maintain 73V until input voltage falls below the UVLO.

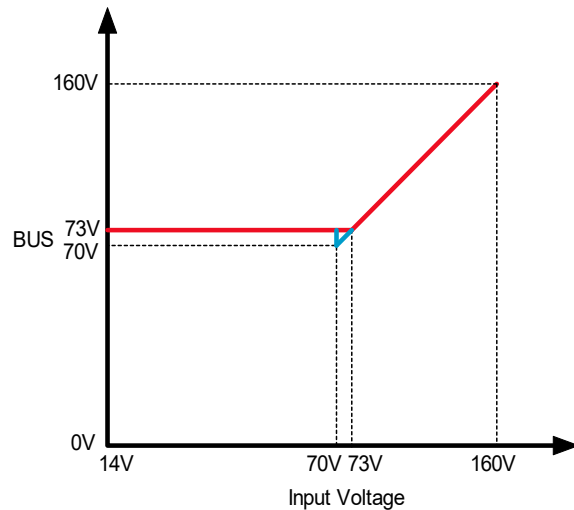

## 7. Input / Output Considerations

### 7.1 Hold up Time

Hold up time is defined as the duration of time that DC/DC converter output will remain active following a loss of input power. The test condition and test curve refer to below.

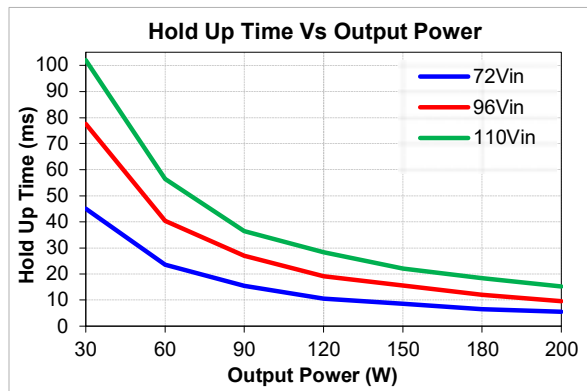
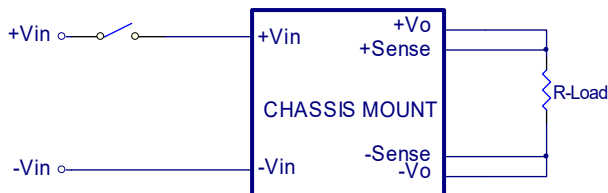

To meet power supply interruptions, an external circuit is required, shown below.



# CHASSIS MOUNT CHB200W12-72S CMFD Series Application Note V10

## 7.2 Output Ripple and Noise

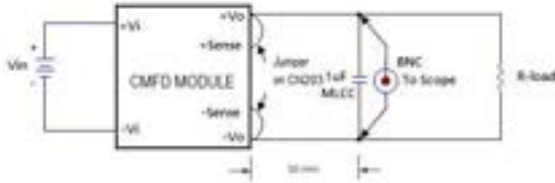

Output ripple and noise measured with 1uF ceramic capacitors across output. A 20 MHz bandwidth oscilloscope is normally used for the measurement.

The conventional ground clip on an oscilloscope probe should never be used in this kind of measurement. This clip, when placed in a field of radiated high frequency energy, acts as an antenna or inductive pickup loop, creating an extraneous voltage that is not part of the output noise of the converter.



Another method is shown in below, in case of coaxial-cable/BNC is not available. The noise pickup is eliminated by pressing scope probe ground ring directly against the -Vout terminal while the tip contacts the +Vout terminal. This makes the shortest possible connection across the output terminals.

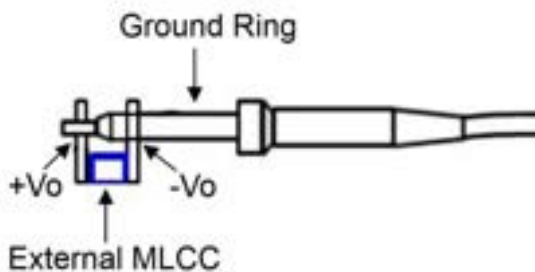

## 7.3 Output Capacitance

The CHB200W12-72SXX-CMFD series converters provide unconditional stability with or without external capacitors. For good transient response, low ESR output capacitors should be located close to the point of load (<100mm). PCB design emphasizes low resistance and inductance tracks in consideration of high current applications. Output capacitors with their associated ESR values have an impact on loop stability and bandwidth. Cincon's converters are designed to work with load capacitance to see technical specifications.



# CHASSIS MOUNT CHB200W12-72S CMFD Series Application Note V10

## 8. Series and Parallel Operation

### 8.1 Series Operation

Series operation is possible by connecting the outputs two or more units. Connection is shown in below. The output current in series connection should be lower than the lowest rate current in each power module

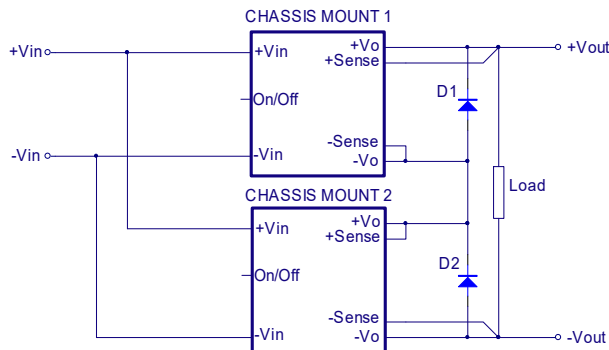

Simple Series Operation Connect Circuit

**Note:**

Recommend Schottky diode (D1, D2) be connected across the output of each series connected converter, so that if one converter shuts down for any reason, then the output stage won't be thermally overstressed. Without this external diode, the output stage of the shut-down converter could carry the load current provided by the other series converters, with its MOSFETs conducting through the body diodes. The MOSFETs could then be overstressed and fail. The external diode should be capable of handling the full load current for as long as the application is expected to run with any unit shut down.

Series for  $\pm$ output operation is possible by connecting the outputs two units, as shown in the schematic below.

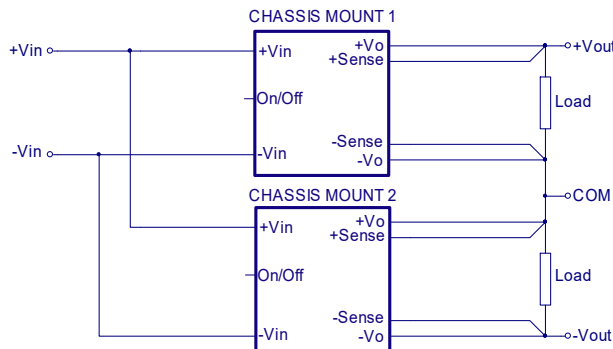

Simple  $\pm$ Output Operation Connect Circuit

### 8.2 Parallel Operation

The CHB200W12-72SXX-CMFD series parallel operation is not possible.

### 8.3 Redundant Operation

Parallel for redundancy operation is possible by connecting the units as shown in the schematic below. The current of each converter become unbalance by a slight difference of the output voltage. Make sure that the output voltage of units of equal value and the output current from each power supply does not exceed the rate current. Suggest use an internal variable resistor to adjust output voltage from each power supply.

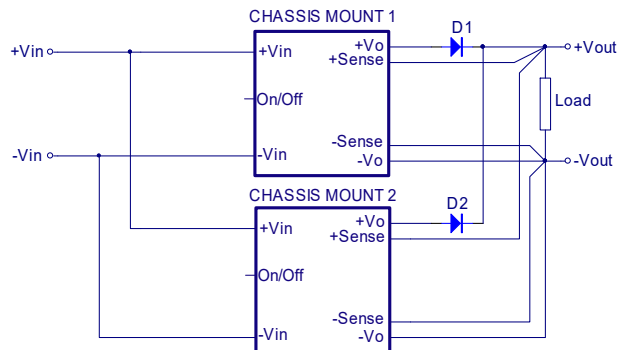

Simple Redundant Operation Connect Circuit



# CHASSIS MOUNT CHB200W12-72S CMFD Series

## Application Note V10

---

### 9. Thermal Design

#### 9.1 Operating Temperature Range

The CHB200W12-72SXX-CMFD series converters can be operated within a wide case temperature range of -40°C to 95°C. Consideration must be given to the derating curves when ascertaining maximum power that can be drawn from the converter. The maximum power drawn from chassis mount models is influenced by usual factors, such as:

- Input voltage range
- Output load current
- Forced air or natural convection
- Heat sink optional

#### 9.2 Convection Requirements for Cooling

To predict the approximate cooling needed for the half brick module, refer to the power derating curves in **section 9.4**. These derating curves are approximations of the ambient temperatures and airflows required to keep the power module temperature below its maximum rating. Once the module is assembled in the actual system, the module's temperature should be monitored to ensure it does not exceed 100°C as measured at the center part of aluminum base plate.

#### 9.3 Thermal Considerations

The power module operates in a variety of thermal environments; however, sufficient cooling should be provided to help ensure reliable operation of the unit. Heat is removed by conduction, convection, and radiation to the surrounding environment. The example is presented in **section 9.4**. The power output of the module should not be allowed to exceed rated power ( $V_{o\_set} \times I_{o\_max}$ ).

#### 9.4 Power Derating

The operating case temperature range of CHB200W12-72SXX-CMFD series is -40°C to 95°C. When operating the CHB200W12-72SXX-CMFD series, proper derating or cooling is needed. The maximum case temperature under any operating condition should not exceed 100°C. The following curve is the de-rating curve of CHB200W12-72SXX-CMFD series with heat sink at nominal  $V_{in}$  and Natural Convection.



# CHASSIS MOUNT CHB200W12-72S CMFD Series Application Note V10

The test condition refer to following figures.

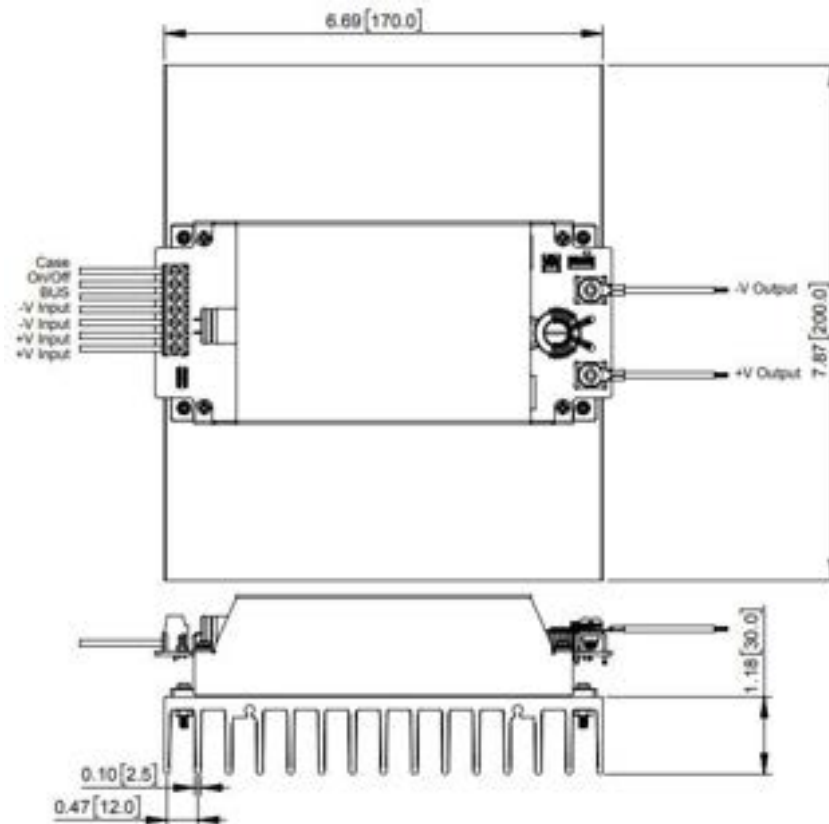

Figures 1 CHB200W12-72SXX-CMFD with Heat Sink (7.87x6.7x1.18inch)

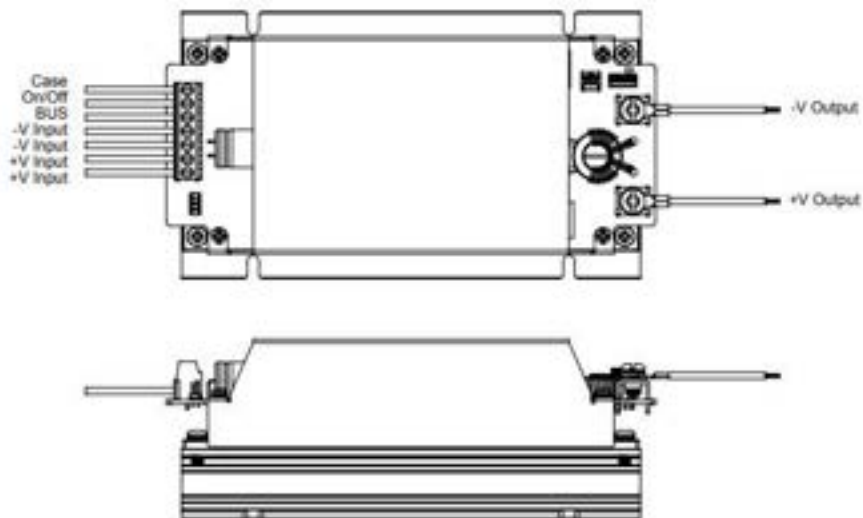

Figures 2 CHB200W12-72SXX-CMFD with Heat Sink CMLH02



# CHASSIS MOUNT CHB200W12-72S CMFD Series Application Note V10

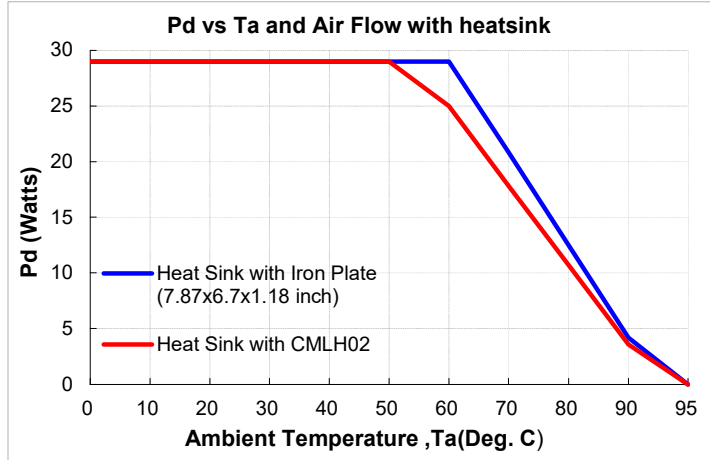

AIR FLOW RATE	TYPICAL R <sub>ca</sub>
Heat Sink (7.87x6.7x1.18 inch)	1.2 °C/W
Heat Sink with CMLH02	1.4 °C/W

Example (with heat sink):

How to make a CHB200W12-72S12-CMFD operating at nominal line voltage, an output current of 16.67A, and a maximum ambient temperature of 55°C?

**Solution:**

**Given:**

$$V_{in}=72Vdc, V_o=12Vdc, I_o=16.67A$$

**Determine Power dissipation (P<sub>d</sub>):**

$$P_d=P_i-P_o=P_o(1-\eta)/\eta$$

$$P_d=12.0 \times 16.67 \times (1-0.895)/0.895=23.47Watts$$

**Determine airflow:**

$$\text{Given: } P_d=23.47W \text{ and } T_a=55^\circ C$$

**Check above Power de-rating curve:**

Heat sink with 7.87x6.7x1.18inch

**Verify:**

$$\text{Maximum temperature rise is } \Delta T = P_d \times R_{ca}=23.47 \times 1.2=28.16^\circ C$$

$$\text{Maximum case temperature is } T_c=T_a+\Delta T=83.2^\circ C < 95^\circ C$$

**Where:**

The R<sub>ca</sub> is thermal resistance from case to ambient environment

T<sub>a</sub> is ambient temperature and T<sub>c</sub> is case temperature



# CHASSIS MOUNT CHB200W12-72S CMFD Series Application Note V10

## 9.5 Heat Sink

Heat sinks assembly [refer to Datasheet-Thermal](#)

## 10. Safety & EMC

### 10.1 Input Fusing and Safety Considerations

The CHB200W12-72SXX-CMFD series converters have no internal fuse. In order to achieve maximum safety and system protection, always use an input line fuse. We recommended a 25A time delay fuse. CHB200W12-72SXX-CMFD module have a transient voltage suppressor diode (TVS) across the input terminal to protect the unit against surge or spike voltage and input reverse voltage (as shown).

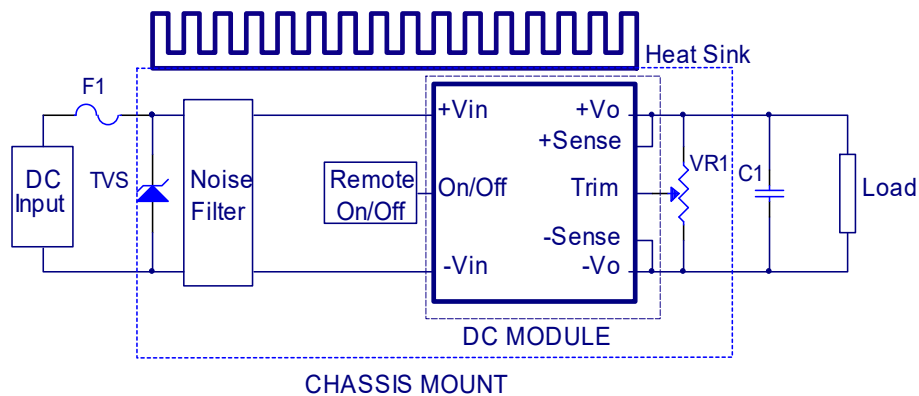

### 10.2 EMC Considerations

EMI Test standard: EN 50121-3-2:2016 Conducted & Radiated Emission  
Test Condition: Input Voltage: 110Vdc, Output Load: Full Load

(1) EMI meet EN 50121-3-2:2016:

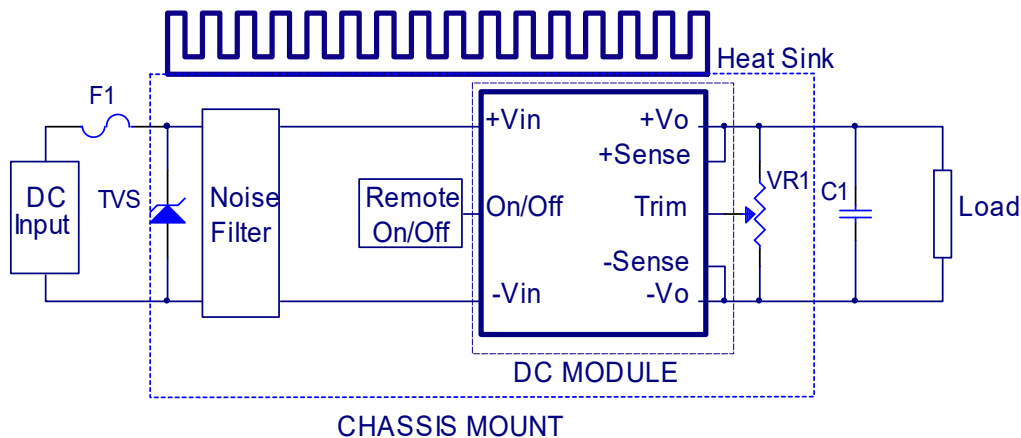



# CHASSIS MOUNT CHB200W12-72S CMFD Series Application Note V10

## Conducted Emission(Input):

CHB200W12-72S12-CMFD

Line

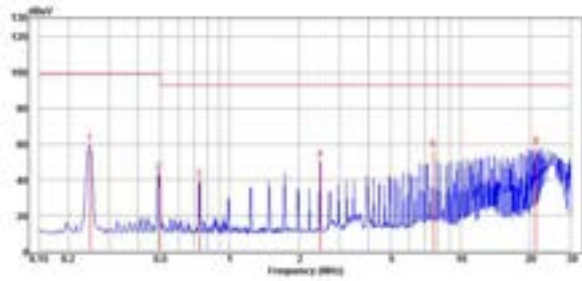

Neutral

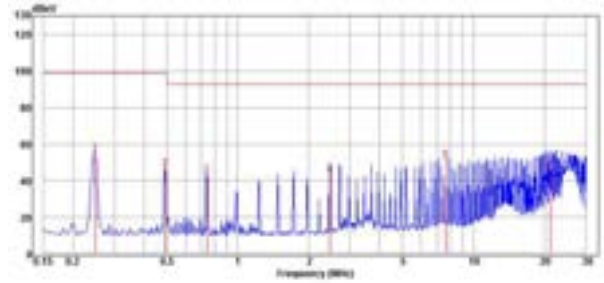

CHB200W12-72S15-CMFD

Line

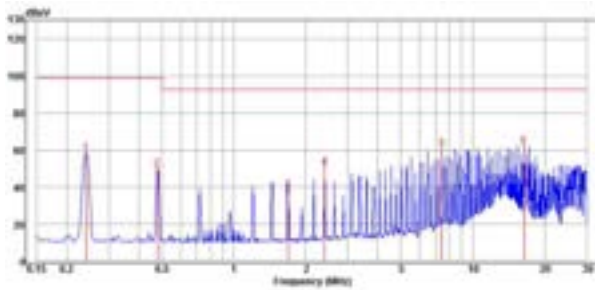

Neutral

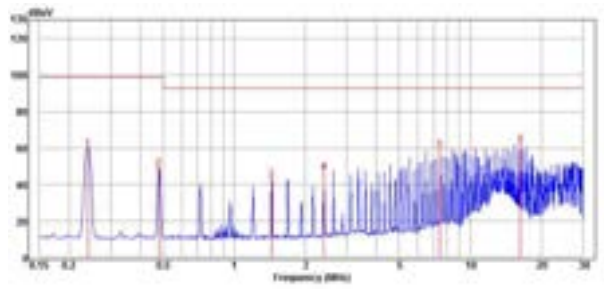

CHB200W12-72S24-CMFD

Line

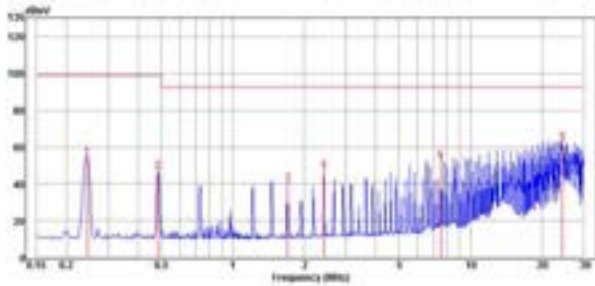

Neutral

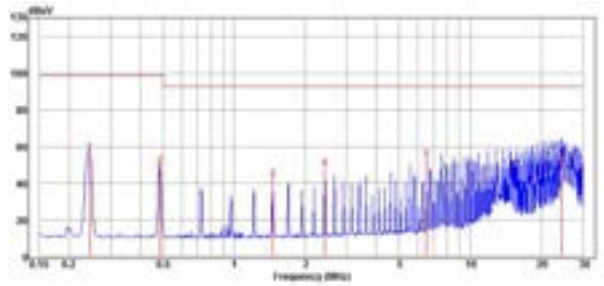



# CHASSIS MOUNT CHB200W12-72S CMFD Series Application Note V10

CHB200W12-72S48-CMFD

Line

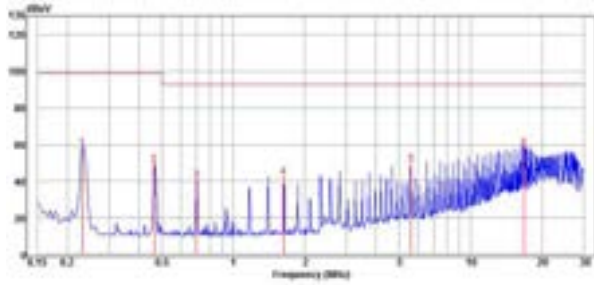

Neutral

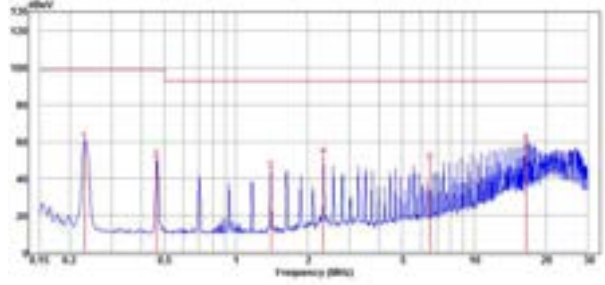



# CHASSIS MOUNT CHB200W12-72S CMFD Series Application Note V10

## Conducted Emission(Output):

CHB200W12-72S12-CMFD

Positive

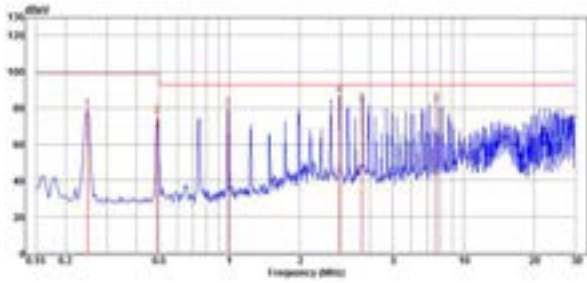

Negative

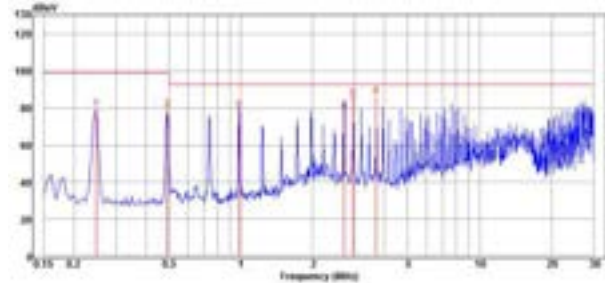

CHB200W12-72S15-CMFD

Positive

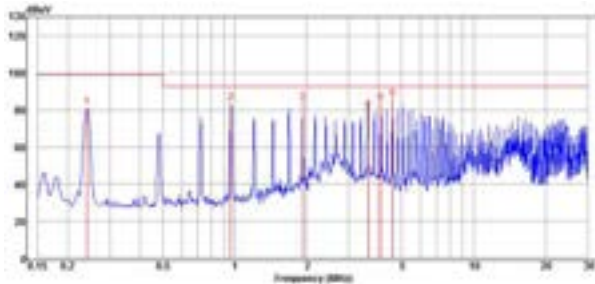

Negative

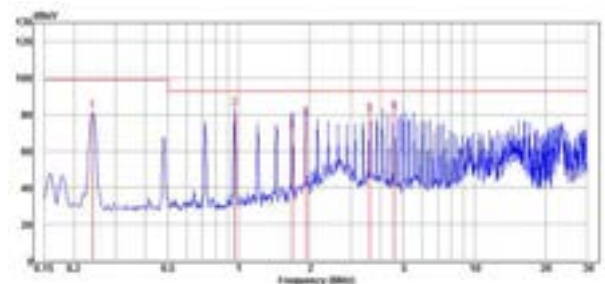

CHB200W12-72S24-CMFD

Positive

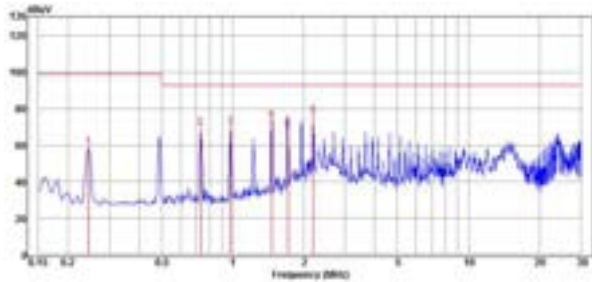

Negative

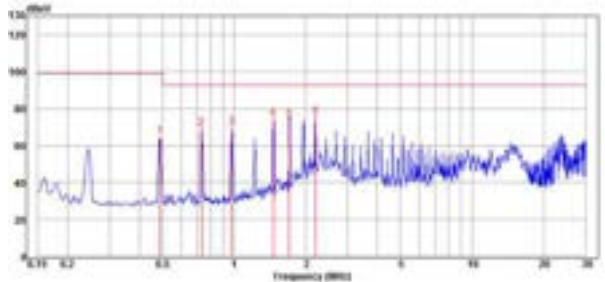



# CHASSIS MOUNT CHB200W12-72S CMFD Series Application Note V10

CHB200W12-72S28-CMFD

Positive

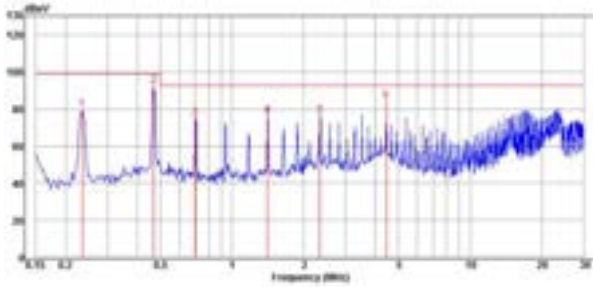

Negative

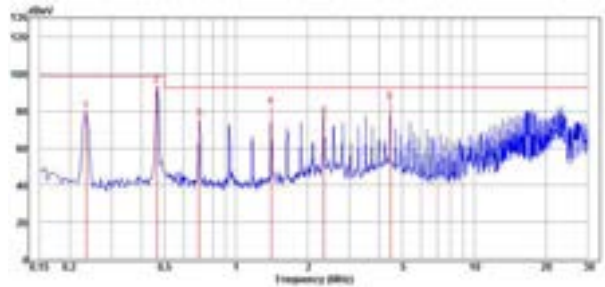

## Radiated Emission:

CHB200W12-72S12-CMFD

Vertical

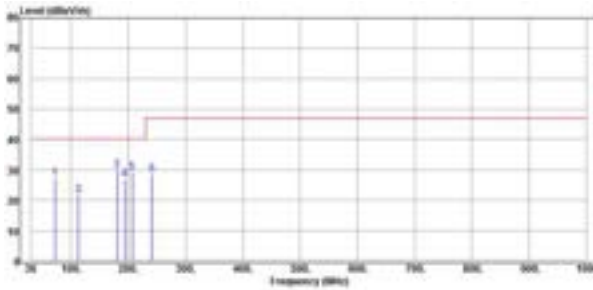

Horizontal

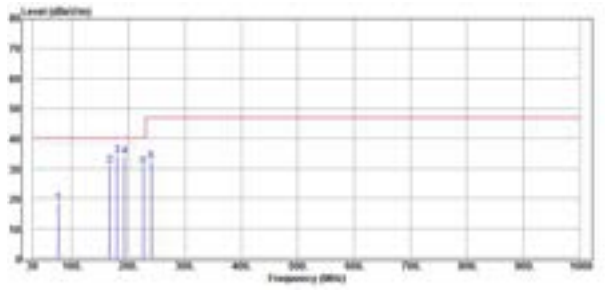

CHB200W12-72S15-CMFD

Vertical

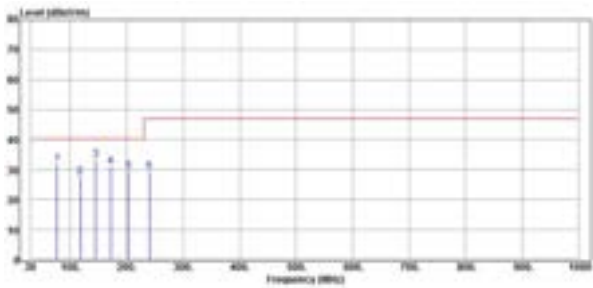

Horizontal

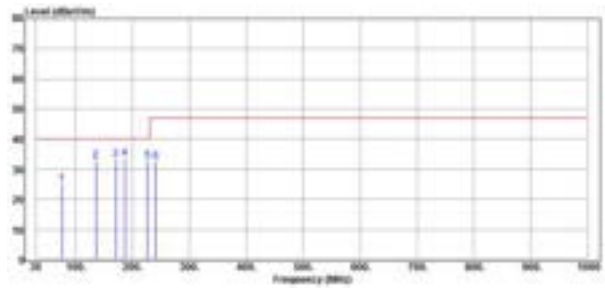



# CHASSIS MOUNT CHB200W12-72S CMFD Series Application Note V10

CHB200W12-72S24-CMFD

Vertical

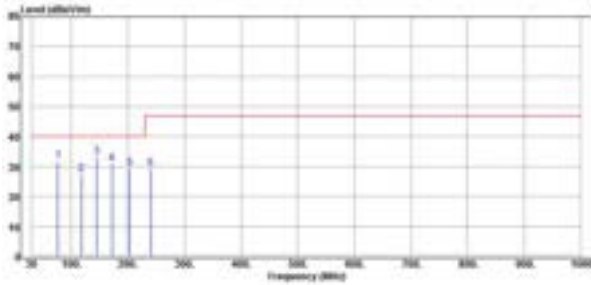

Horizontal

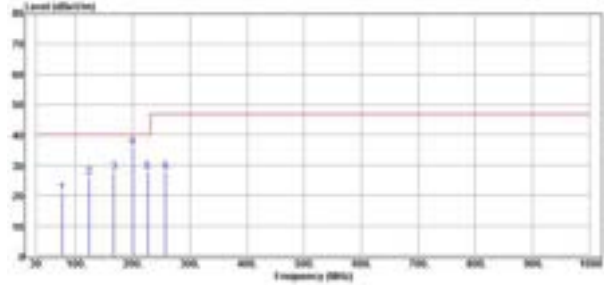

CHB200W12-72S48-CMFD

Vertical

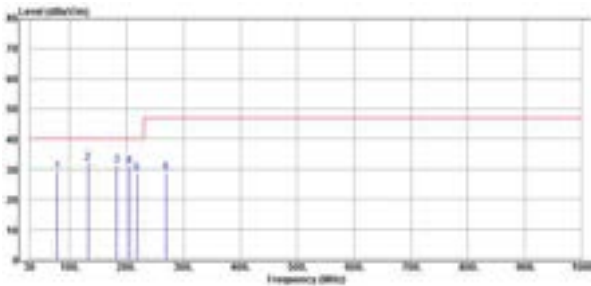

Horizontal

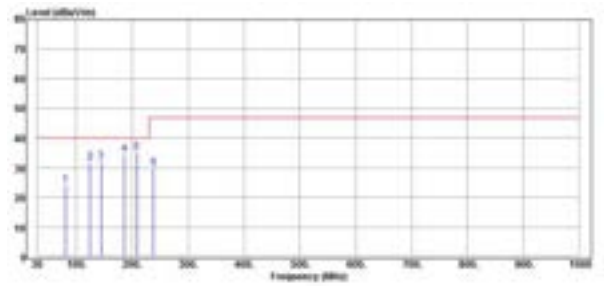

## Headquarters:

14F, No.306, Sec.4, Hsin Yi Rd.  
Taipei, Taiwan  
Tel: 886-2-27086210  
Fax: 886-2-27029852  
E-mail: [sales@cincon.com.tw](mailto:sales@cincon.com.tw)  
Web Site: <https://www.cincon.com>

## CINCON ELECTRONICS CO., LTD.

### Factory:

No. 8-1, Fu Kung Rd.  
Fu Hsing Industrial Park  
Fu Hsing Hsiang,  
ChangHua Hsien, Taiwan  
Tel: 886-4-7690261  
Fax: 886-4-7698031

### Cincon North America:

1655Mesa Verde Ave. Ste 180  
Ventura, CA93003  
Tel: 805-639-3350  
Fax: 805-639-4101  
E-mail: [info@cincon.com](mailto:info@cincon.com)