

1W/3W, AC/DC converter

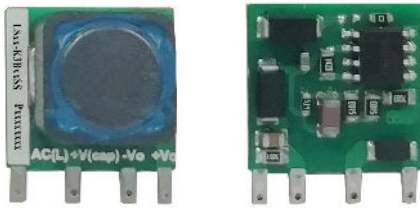

FEATURES

- Ultra-wide 85 - 305VAC and 70 - 430VDC input voltage range
- Operating ambient temperature range -40°C to +85°C
- Compact size, open frame
- High reliability, green power
- Industrial-grade design
- Flexible selection of EMC additional circuits, simplify customer PCB layout
- Output short circuit, over-current protection
- EN62368 safety approval

LSxx-K3BxxSS series is one of Mornsun's highly efficient green power AC-DC Converter series. It features wide input voltage range, accepting both DC and AC input voltage, high efficiency and low power consumption. The products are widely used in industrial control instrumentation, electric power applications and smart home type applications, the need to meet UL/CE safety certifications and lower demand for EMC compliance levels. For extremely harsh EMC environment, we recommend using the application circuit show in Design Reference of this datasheet.

Selection Guide

Certification	Part No.	Output Power	Nominal Output Voltage and Current(Vo/Io)	Efficiency at 230VAC (%) Typ.	Capacitive Load (μF) Max.
CE	LS01-K3B05SS	1W	5V/200mA	57	500
	LS03-K3B12SS	3W	12V/250mA	73	330

Warning: Non-isolated power supply, there is no insulation protection between output and input dangerous voltage, beware of electric shock!

Input Specifications

Item	Operating Conditions	Min.	Typ.	Max.	Unit
Input Voltage Range	AC input	85	--	305	VAC
	DC input	70	--	430	VDC
Input Frequency		47	--	63	Hz
Input Current	115VAC	--	--	0.12	A
	277VAC	--	--	0.06	
Inrush Current	115VAC	--	25	--	
	277VAC	--	40	--	
Recommended External Input Fuse		1A/300V, slow-blow, required			
Hot Plug		Unavailable			

Output Specifications

Item	Operating Conditions	Min.	Typ.	Max.	Unit	
Output Voltage Accuracy	10% - 100% load	5V	--	±1.5	-7~+3	%
		12V	--	±2.5	-5~+8	
Line Regulation	Rated load	5V	--	±1.5	--	
		12V	--	±1	--	
Load Regulation	5V	--	±2.5	--		
	12V	--	±2	--		
Ripple & Noise*	20MHz bandwidth (peak-to-peak value)	--	80	150	mV	
Temperature Coefficient		--	±0.12	--	%/°C	
Stand-by Power Consumption	230VAC input	5V	--	--	0.3	W
		12V	--	--	0.4	
Short Circuit Protection		Hiccup, continuous, self-recovery				
Over-current Protection		≥110%Io, self-recovery				
Min. Load		10	--	--	%	

Note: * The "parallel cable" method is used for ripple and noise test, please refer to AC-DC Converter Application Notes for specific information.

General Specifications

Item	Operating Conditions	Min.	Typ.	Max.	Unit
Operating Temperature		-40	--	+85	°C
Storage Temperature		-40	--	+105	
Storage Humidity		--	--	95	%RH
Power Derating	-40°C to -20°C	2	--	--	% / °C
	+70°C to +85°C	2.67	--	--	
	85VAC - 110VAC	0.8	--	--	% / VAC
	277VAC - 305VAC	1.1	--	--	
Safety Standard		IEC62368/EN62368/UL62368			
Safety Certification		EN62368			
MTBF		MIL-HDBK-217F@25°C>300,000 h			

Mechanical Specifications

Dimension	16.13 x 15.10 x 9.50 mm
Weight	4.2g (Typ.)
Cooling method	Free air convection

Electromagnetic Compatibility (EMC)

Emissions	CE	CISPR32/EN55032	CLASS A (See Fig. 1 for typical application circuit)	
		CISPR32/EN55032	CLASS B (See Fig. 2 for recommended circuit)	
	RE	CISPR32/EN55032	CLASS A (See Fig. 1 for typical application circuit)	
		CISPR32/EN55032	CLASS B (See Fig. 2 for recommended circuit)	
Immunity	ESD	IEC/EN61000-4-2	Contact ± 6KV / Air ± 8KV (See Fig. 1 for typical application circuit)	perf. Criteria B
	RS	IEC/EN61000-4-3	10V/m (See Fig. 2 for recommended circuit)	perf. Criteria A
	EFT	IEC/EN61000-4-4	±2KV (See Fig. 1 for typical application circuit)	perf. Criteria B
		IEC/EN61000-4-4	±4KV (See Fig. 2 for recommended circuit)	perf. Criteria B
	Surge	IEC/EN61000-4-5	line to line ±1KV (See Fig. 1 for typical application circuit)	perf. Criteria B
	CS	IEC/EN61000-4-6	10Vr.m.s (See Fig. 2 for recommended circuit)	perf. Criteria A
	Voltage dips, short interruptions and voltage variations immunity	IEC/EN61000-4-11	0%, 70% (See Fig. 2 for recommended circuit)	perf. Criteria B

Product Characteristic Curve

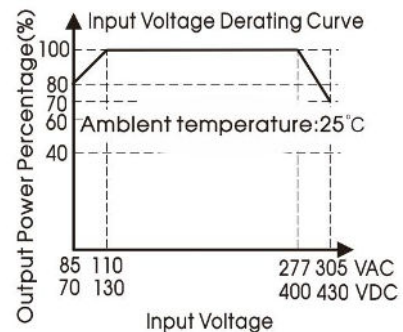
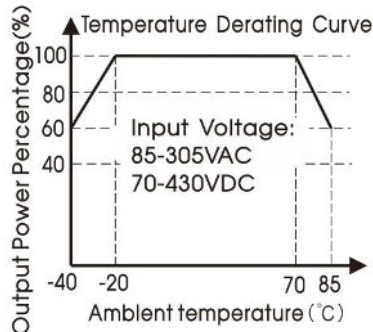

Note:

- ① With an AC input between 85 - 110VAC/277 - 305VAC and a DC input between 70 - 130VDC/400 - 430VDC, the output power must be derated as per temperature derating curves;
- ② This product is suitable for applications using natural air cooling; for applications in closed environment please consult factory or one of our FAE.

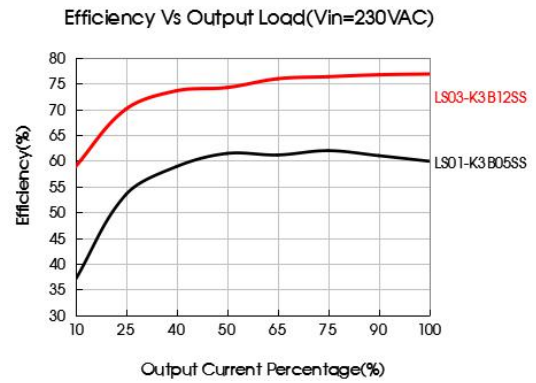
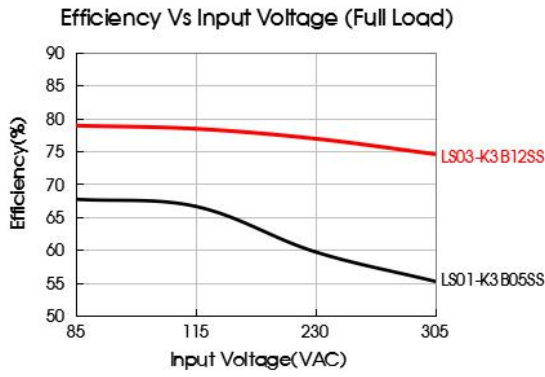

Design Reference

1. Typical application

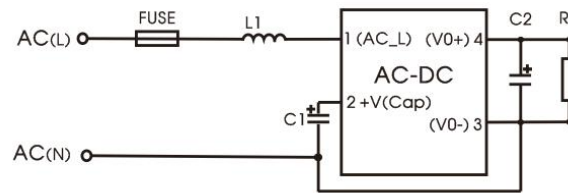

Fig. 1

Part No.	FUSE (required)	C1 (required)	C2 (required)	L1 (required)
LS01-K3B05SS	1A/300V	10uF/400V: 165-264VAC	220uF/16V	1.2mH
LS03-K3B12SS		10uF/450V: 165-305VAC 22uF/400V: 85-264VAC 22uF/450V: 85-305VAC		

Note:
C1 is used as filter capacitor(required), if the surge immunity index is to be met, the C1 capacitor needs to be connected to 22uF;
Output filter: We recommend using an electrolytic capacitor with high frequency, high ripple current and low ESR rating for C2 refer to manufacture's datasheet). Combined with L1, they form a pi-type filter circuit. Choose a Capacitor voltage rating with at least 20% margin, in other words not exceeding 80%.

2. EMC compliance recommended circuit

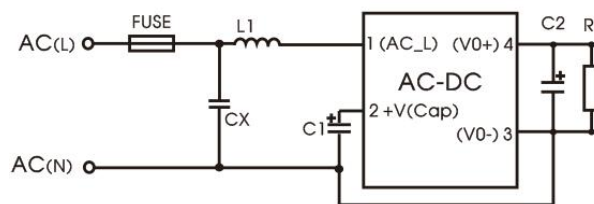

Fig 2

Components	Recommend Parameter
CX	0.1μF/310VAC
L1	1.2mH
FUSE (required)	1A/300V, slow-blow, required
C1 (required)	10uF/400V: 165-264VAC 10uF/450V: 165-305VAC 22uF/400V: 85-264VAC 22uF/450V: 85-305VAC
C2 (required)	220uF/16V

3. For additional information please refer to application notes on www.mornsun-power.com.

LSxx-K3BxxSS Dimensions and Recommended Layout

THIRD ANGLE PROJECTION 

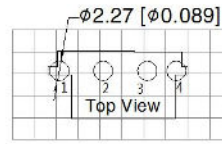
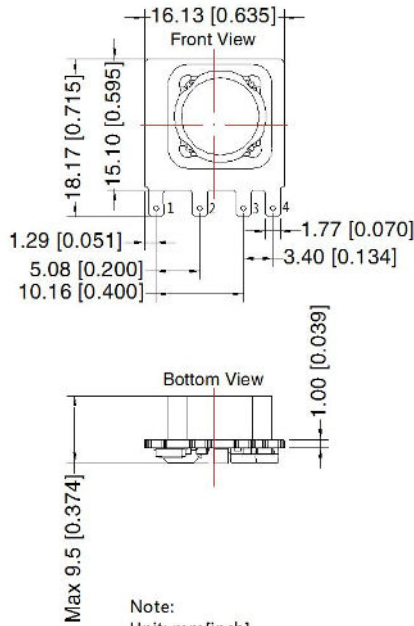

Note: Grid: 2.54*2.54mm

Pin-Out	
Pin	Function
1	AC(L)
2	+V(CAP)
3	AC(N)/-Vo
4	+Vo

Note:
 Unit: mm[inch]
 General tolerances: ± 1.0 [± 0.04]
 The layout of the device is for reference only,
 please refer to the actual product

- Note:
- For additional information on Product Packaging please refer to www.mornsun-power.com. Packaging bag number: 58220098;
 - External electrolytic capacitors are required to modules, more details refer to typical applications;
 - Unless otherwise specified, parameters in this datasheet were measured under the conditions of $T_a=25^\circ\text{C}$, humidity<75%, nominal input voltage (115Vac and 230Vac) and rated output load;
 - In order to improve the efficiency at light load, there will be audible noise generated, but it does not affect product performance and reliability.
 - The module needs to be glued and fixed after assembly.
 - All index testing methods in this datasheet are based on our company corporate standards;
 - We can provide product customization service, please contact our technicians directly for specific information;
 - Products are related to laws and regulations: see "Features" and "EMC";
 - Our products shall be classified according to ISO14001 and related environmental laws and regulations, and shall be handled by qualified units.

MORNSUN Guangzhou Science & Technology Co., Ltd.

Address: No. 5, Kehui St. 1, Kehui Development Center, Science Ave., Guangzhou Science City, Huangpu District, Guangzhou, P. R. China
 Tel: 86-20-38601850 Fax: 86-20-38601272 E-mail: info@mornsun.cn www.mornsun-power.com