



FEATURES

- Universal 90 - 264VAC or 127 - 370VDC input voltage
- Operating ambient temperature range: -40°C to +70°C
- Built-in active PFC function
- Output short circuit, over-current, over-voltage protection, over-temperature protection
- 250W with air cooling, 450W with 25CFM
- 5VDC standby output, 12VDC fan supply, power good, power fail and remote sense
- Suitable for BF application
- Operating altitude up to 5000m



UL62368-1



EN62368-1
EN60601-1

RoHS



LOF450-20Bxx-C(-CF) series is one of Mornsun's enclosed AC-DC switching power supply and suitable for all kinds of BF type (be accessible to patients) medical system equipment. It features universal AC input and at the same time accepts DC input voltage, cost-effective, low no load power consumption, high efficiency, high reliability and double or reinforced insulation. These converters offer excellent EMC performance and meet IEC/EN/UL62368, GB4943, IEC/EN60335, IEC/EN61558, IEC/EN/ES60601-1 standards and they are widely used in areas of industrial, LED, street light control, electricity, security, telecommunications, smart home, etc.

Selection Guide

Certification	Part No.*	Cooling method*	Output Power (W)*	Nominal Output Voltage and Current (Vo/Io)	Output Voltage Adjustable Range ADJ (V)	Efficiency at 230VAC (%) Typ. *	Capacitive Load (μF) Max.
UL/EN	LOF450-20B12-C	Air cooling	249.6	12V/20.8A	11.4 -12.6	91	6000
		25CFM	399.6	12V/33.3A			
	LOF450-20B15-C	Air cooling	250.5	15V/16.7A	14.25 -15.75	92	6000
		25CFM	400.5	15V/26.7A			
	LOF450-20B24-C	Air cooling	252	24V/10.5A	22.8 -25.2	93	6000
		25CFM	450	24V/18.75A			
	LOF450-20B27-C	Air cooling	251.1	27V/9.3A	25.65 - 28.35	93.5	4000
		25CFM	450.9	27V/16.7A			
	LOF450-20B36-C	Air cooling	250.2	36V/6.95A	34.2 - 37.8	93	3000
		25CFM	450	36V/12.5A			
	LOF450-20B48-C	Air cooling	254.4	48V/5.3A	45.6 - 50.4	94	2000
		25CFM	451.2	48V/9.4A			
	LOF450-20B12-CF	Forced air cooling, 25CFM	399.6	12V/33.3A	11.4 -12.6	91	6000
	LOF450-20B15-CF	Forced air cooling, 25CFM	400.5	15V/26.7A	14.25 -15.75	92	6000
	LOF450-20B24-CF	Forced air cooling, 25CFM	450.0	24V/18.75A	22.8 - 25.2	93	6000
	LOF450-20B27-CF	Forced air cooling, 25CFM	450.9	27V/16.7A	25.65 - 28.35	93.5	4000
	LOF450-20B36-CF	Forced air cooling, 25CFM	450.0	36V/12.5A	34.2 - 37.8	93	3000
	LOF450-20B48-CF	Forced air cooling, 25CFM	451.2	48V/9.4A	45.6 - 50.4	94	2000

Notes: 1.*Under any conditions, the total power of the product should not exceed the rated power. When the output voltage is increased, the total output power cannot exceed the rated output power, when the output voltage is decreased, the output current cannot exceed the rated output current ;
 2.*When measuring the full load efficiency, the fan should be connected to an external power supply, Fan loss is not included in the input power;
 3.*LOF Products with shell is also available, named LOF450-20Bxx-C/CF;
 4.*25CFM refers to LOF450-20Bxx-C series external fan speed, forced air cooling 25CFM refers to the built-in fan speed, which automatically starts when the LOF450-20Bxx-CF series are turned on.

Input Specifications

Item	Operating Conditions		Min.	Typ.	Max.	Unit
Input Voltage Range	AC input		90	--	264	VAC
	DC input		127	--	370	VDC
Input Frequency			47	--	63	Hz
Input Current	115VAC		--	--	5.2	A
	230VAC		--	--	2.6	
Inrush Current	115VAC	Cold start	--	40	--	
	230VAC		--	80	--	
Power Factor	115VAC	Full load	0.98	--	--	--
	230VAC		0.95	--	--	--
Leakage Current	264VAC		Contact leakage current		<0.1mA	
			Earth leakage current		<0.5mA	
Hot Plug			Unavailable			

Output Specifications*

Item	Operating Conditions		Min.	Typ.	Max.	Unit
Output Voltage Accuracy*	Full load	12V/15V/24V	--	±2	--	%
		27V/36V/48V	--	±1	--	
Line Regulation	Rated load		--	±0.5	--	%
Load Regulation	0%-100% load		--	±1	--	
Ripple & Noise*	20MHz bandwidth		--	--	200	mV
Temperature Coefficient			--	±0.03	--	%/°C
Minimum Load			0	--	--	%
Hold-up Time	25°C, 115VAC input		12	--	--	ms
	25°C, 230VAC input		16	--	--	ms
Stand-by Power Consumption	Room temperature, 230VAC input, (PS-ON Low level)		--	--	0.5	W
Short Circuit Protection	Recover time <5s after the short circuit disappear		Hiccup, continuous, self-recover			
Over-current Protection			≥ 105%Io, hiccup, self-recover			
Over-voltage Protection*	12V		≤ 15.6VDC (Output voltage turn off, re-power on for recover)			
	15V		≤ 19.5VDC (Output voltage turn off, re-power on for recover)			
	24V		≤ 31.2VDC (Output voltage turn off, re-power on for recover)			
	27V		≤ 35.1VDC (Output voltage turn off, re-power on for recover)			
	36V		≤ 46.8VDC (Output voltage turn off, re-power on for recover)			
	48V		≤ 60.0VDC (Output voltage turn off, re-power on for recover)			
Over-temperature Protection*			Output voltage turn off, auto recover after the temperature drops			
Fan Power*			Offer output power of 12V/0.5A			
PS_ON Input Signal*	Power on	PS_ON High	2	--	5	V
	Power off	PS_ON Low	0	--	0.5	
PG Signal*	Power on	The PG signal goes high with 10ms to 500ms delay after power set up	10	--	500	ms
	Power off/Power fail	The TTL signal goes low at least 1ms before output below 90% of rated value	1	--	--	
	High level	High	2	--	6	V
	Low level	Low	0	--	0.6	

AC/DC 450W Enclosed Switching Power Supply

LOF450-20Bxx-C(-CF) Series

MORNSUN®

Remote Sense*	When RS+ and RS- are connected to the system, with function of remote voltage compensation, if not needed, left RS+ and RS open
5V Standby*	5Vsb: The load capacity is 0.6A without fan, the load capacity is 1A with fan 25CFM; tolerance 2%, ripple: 120mVp-p(max.)

Note: 1.*Output Voltage Accuracy: including setting error, line regulation, load regulation;
 2.*The "Tip and barrel method" is used for ripple and noise test, output parallel 47uF electrolytic capacitor (Low ESR) and 0.1uF ceramic capacitor, please refer to AC-DC Converter Application Notes for specific information;
 3.*Over-Voltage Protection: use the discharge pen to release the input electrolytic charge completely, and then test the restart auto recover.
 4.*For all the above test items, please refer to our company standard "AC-DC Black Box Test Specification" for specific test specifications and methods;
 5.*For fan power connection method, please refer to 5, 6 in the external dimension drawing;
 6.*For PS_ON, 5V standby connection method, please refer to CN6 in the external dimension drawing;
 7.*For PG standby connection method, please refer to CN2 in the external dimension drawing;

General Specifications

Item	Operating Conditions		Min.	Typ.	Max.	Unit			
Isolation Test	Input - output	Electric strength test for 1min. leakage current <5mA	4000	--	--	VAC			
	Input - ⚡		2000	--	--				
	Output - ⚡		1500	--	--				
Insulation Resistance	Input - output	Environment temperature: 25±5℃, Relative humidity: <95%RH, non-condensing Testing voltage: 500VDC	100	--	--	MΩ			
	Input - ⚡		100	--	--				
	Output - ⚡		100	--	--				
Isolation level	Input - output		2 x MOPP						
	Input - ⚡		1 x MOPP						
	Output - ⚡		1 x MOPP						
Operating Temperature			-40	--	+70	℃			
Storage Temperature			-40	--	+85				
Storage Humidity		Non-condensing	10	--	95	%RH			
Operating Humidity			20	--	90				
Power Derating	Operating Temperature derating	LOF450-20B12/15-CF		+50℃ to +70℃	3.15	--	--	% / ℃	
		LOF450-20B24/27/36/48-CF		+50℃ to +70℃	3.35	--	--		
		25CFM	LOF450-20B12/15-C		+50℃ to +70℃	2.5	--		--
			LOF450-20B24/27/36/48-C		+50℃ to +70℃	2.8	--		--
	Air cooling (250W)	115VAC		+40℃ to +60℃	4.5	--	--	W / ℃	
		230VAC		+35℃ to +60℃	4.8	--	--		
Input voltage derating		Input voltage derating	90VAC - 115VAC		1.0	--	--	% / VAC	
			127VDC - 160VDC		0.76	--	--	% / VDC	
Safety Standard		EN/UL62368-1/ EN60601-1 Safety Approval & EN62368-1 (Report); Design refer to IEC/CB62368-1/GB4943-1/EN60335-1							
Safety Class		CLASS I							
MTBF		MIL-HDBK-217F@25℃		>200,000 h					

Mechanical Specifications

Case Material	Metal (AL5052, SUS304)			
Dimension	130×86×43mm	LOF450-20Bxx-C Series	160×86×43mm	LOF450-20Bxx-CF Series
Weight	605g (Typ.)	LOF450-20Bxx-C Series	645g (Typ.)	LOF450-20Bxx-CF Series
Cooling Method*	Air cooling (250W) / 25CFM(400W/450W)			

Note: *Cooling method and power derating refer to typical characteristic curves.

Electromagnetic Compatibility (EMC)*

Emissions	CE	EN55032(CISPR32)/EN55011(CISPR11) CLASS B
	RE	EN55032(CISPR32)/EN55011(CISPR11) CLASS B
	Harmonic current	IEC/EN61000-3-2 CLASS A and CLASS D

MORNSUN®

MORNSUN Guangzhou Science & Technology Co., Ltd.

2021.10.11-A/2 Page 3 of 8

MORNSUN Guangzhou Science & Technology Co., Ltd. reserves the copyright and right of final interpretation

	Flicker	IEC/EN61000-3-3	
Immunity	ESD	IEC/EN61000-4-2	Contact $\pm 8\text{KV}$ /Air $\pm 15\text{KV}$
	RS	IEC/EN61000-4-3	10V/m
	EFT	IEC/EN61000-4-4	$\pm 2\text{KV}$
	Surge	IEC/EN61000-4-5	line to line $\pm 2\text{KV}$, line to ground $\pm 4\text{KV}$
	CS	IEC/EN61000-4-6	10Vr.m.s
	Voltage dips, short interruptions and voltage variations immunity	IEC/EN61000-4-11	0%, 70%

Note: *The power supply should be considered as a part of the components in the system. All EMC performance are been tested on a metal plate with a thickness of 1mm and a length of 360mm x 360mm. The power supply must be combined with the terminal equipment for electromagnetic compatibility confirmation.

Product Characteristic Curve

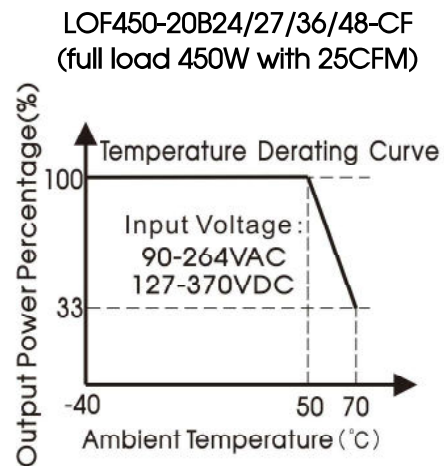
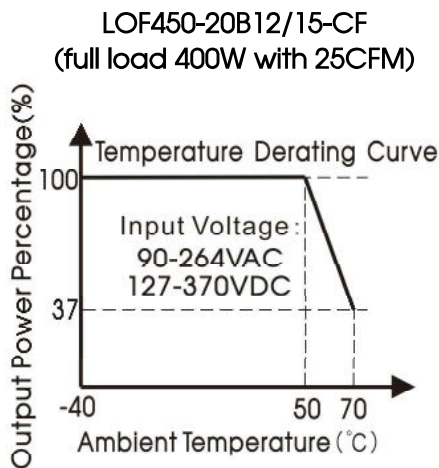
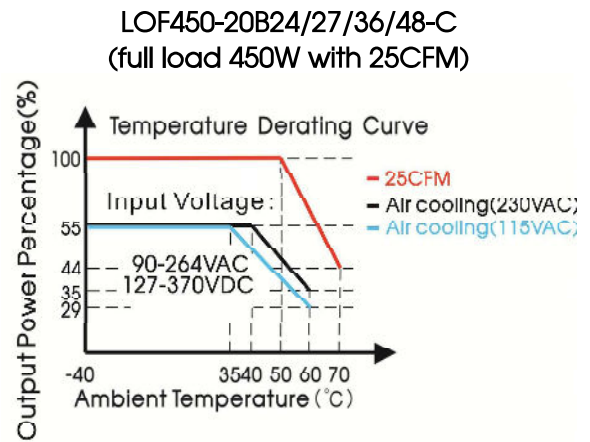
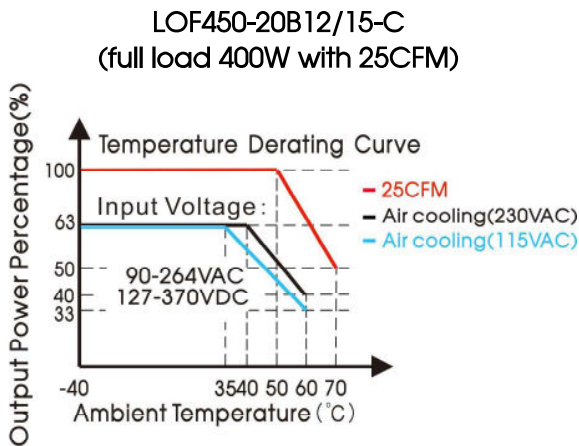

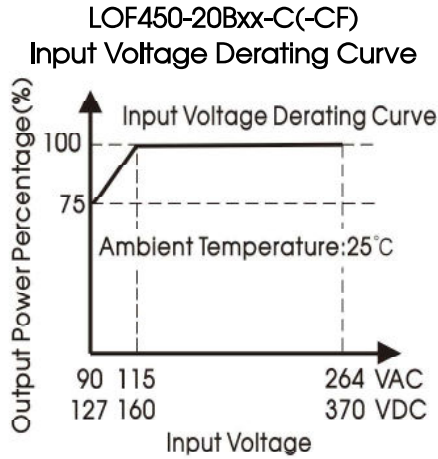

Note: With an AC input voltage between 90 - 115VAC and a DC input between 127 - 160VDC the output power must be derated as per the temperature derating curves

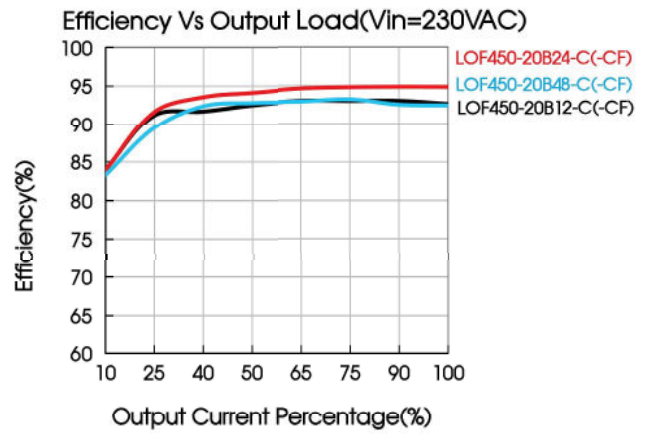
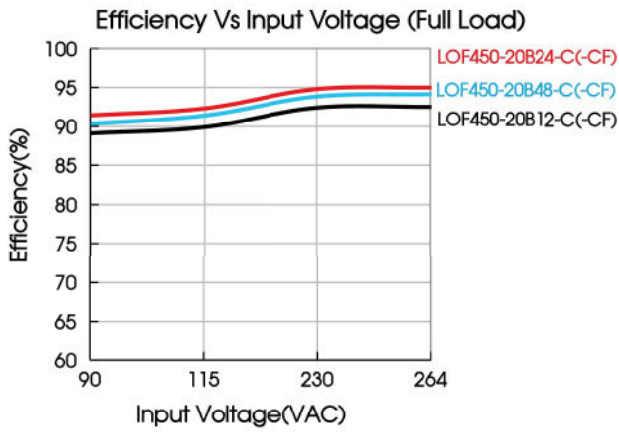

Dimensions and Recommended Layout

LOF450-20Bxx-C Series

THIRD ANGLE PROJECTION 

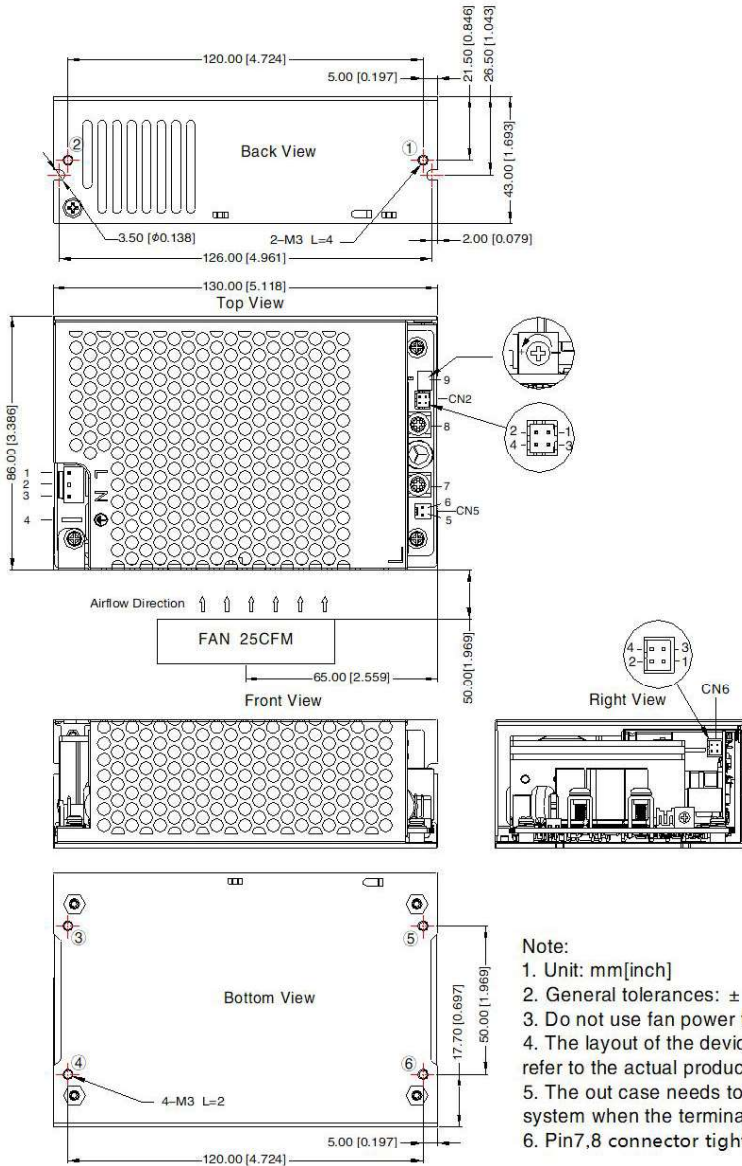

Pin-Out		Customer Connector
Pin	Mark	Housing: JST VHR or equivalent Contact: JST SVH-21T-P1.1 or equivalent
1	AC(L)	
2	NC	
3	AC(N)	
4		CN5: Fan power output port Housing: TKP 2502 or equivalent Contact: TKP 8811 or equivalent
5	FAN+	
6	FAN-	
7	+Vo	
8	-Vo	
9	ADJ Output adjustable resistor	

Pin-Out		Customer Connector
Pin	Mark	Housing: JST PHD-2*2Y or equivalent Contact: JST PHD-TE or equivalent
1	+5V	
2	GND	
3	PS-ON	
4	GND	

Pin-Out		Customer Connector
Pin	Mark	Housing: JST PHD-2*2Y or equivalent Contact: JST PHD-TE or equivalent
1	RS-	
2	RS+	
3	GND	
4	PG	

Position	Screw Spec.	L(max)	Torque(max)
①-②	M3	4mm	0.4N·m
③-⑥	M3	2mm	0.4N·m

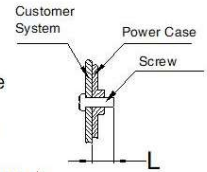

LOF450-20Bxx-CF Series

AC/DC 450W Enclosed Switching Power Supply

LOF450-20Bxx-C(-CF) Series

MORNSUN®

THIRD ANGLE PROJECTION 

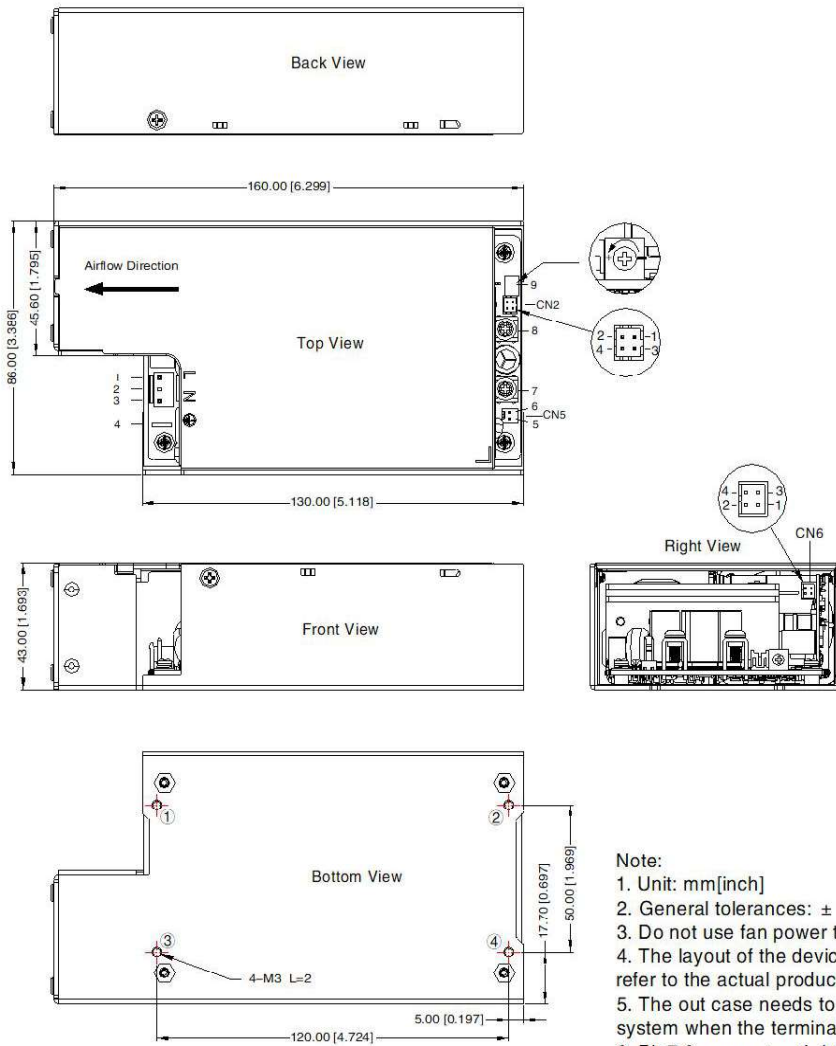

Pin-Out		Customer Connector
Pin	Mark	Housing: JST VHR or equivalent Contact: JST SVH-21T-P1.1 or equivalent
1	AC(L)	
2	NC	
3	AC(N)	
4	⊕	CN5: Fan power output port Housing: TKP 2502 or equivalent Contact: TKP 8811 or equivalent
5	FAN+	
6	FAN-	
7	+Vo	
8	-Vo	
9	ADJ Output adjustable resistor	

4-3 2-1 CN6: PS_ON signal input port(3-4)
5VDC Standby output(1-2)

Pin-Out		Customer Connector
Pin	Mark	Housing: JST PHD-2*2Y or equivalent Contact: JST PHD-TE or equivalent
1	+5V	
2	GND	
3	PS-ON	
4	GND	

2-1 4-3 CN2: Remote sensing signal input port(1-2)
PG signal(3-4)

Pin-Out		Customer Connector
Pin	Mark	Housing: JST PHD-2*2Y or equivalent Contact: JST PHD-TE or equivalent
1	RS-	
2	RS+	
3	GND	
4	PG	

Position	Screw Spec.	L(max)	Torque(max)
①-④	M3	2mm	0.4N·m

- Note:**
- Unit: mm[inch]
 - General tolerances: $\pm 1.00[\pm 0.039]$
 - Do not use fan power to power other devices
 - The layout of the device is for reference only, please refer to the actual product
 - The out case needs to be connected to the earth of system when the terminal
 - Pin7,8 connector tightening torque: M4, 1.2N · m(max)

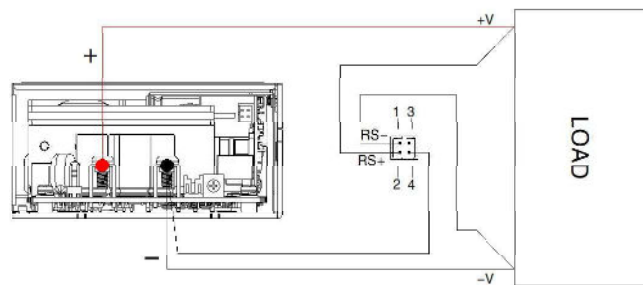
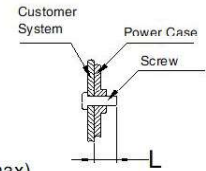

Remote sensing function wiring diagram

Note:

- RS - and RS + cannot be shorted or reversed, otherwise the power module will be damaged;
- The remote compensation function can compensate the voltage drop on the output cable, which includes the sum of the cable drop connected to the output positive terminal and the output negative terminal;
- If you need to use remote compensation function, the signal pin needs to be connected with the load and with a twisted pair, otherwise the power module will be damaged.

Note:

1. For additional information on Product Packaging please refer to www.mornsun-power.com. Packaging bag number: 58220219(LOF450-20Bxx-C); 58220220(LOF450-20Bxx-CF);
2. Unless otherwise specified, parameters in this datasheet were measured under the conditions of $T_a=25^{\circ}\text{C}$, humidity<75%RH with nominal input voltage and rated output load;
3. All index testing methods in this datasheet are based on our company corporate standards;
4. In order to improve the efficiency, there will be audible noise generated when working at light load, but it does not affect product performance and reliability;
5. We can provide product customization service, please contact our technicians directly for specific information;
6. Products are related to laws and regulations: see "Features" and "EMC";
7. The out case needs to be connected to PE (\oplus) of system when the terminal equipment in operating;
8. CAUTION: Double pole, neutral fusing. Disconnect mains before servicing. /"ATTENTION: Double pôle/fusible sur le neutre. Débrancher l'alimentation avant l'entretien;
9. Our products shall be classified according to ISO14001 and related environmental laws and regulations, and shall be handled by qualified units;
10. The power supply is considered a component which will be installed into a terminal equipment. All EMC tests should be confirmed with the final equipment. Please consult our FAE for EMC test operation instructio

Mornsun Guangzhou Science & Technology Co., Ltd.

Address: No. 5, Kehui St. 1, Kehui Development Center, Science Ave., Guangzhou Science City, Huangpu District, Guangzhou, P. R. China
Tel: 86-20-38601850 Fax: 86-20-38601272 E-mail: info@mornsun.cn www.mornsun-power.com