

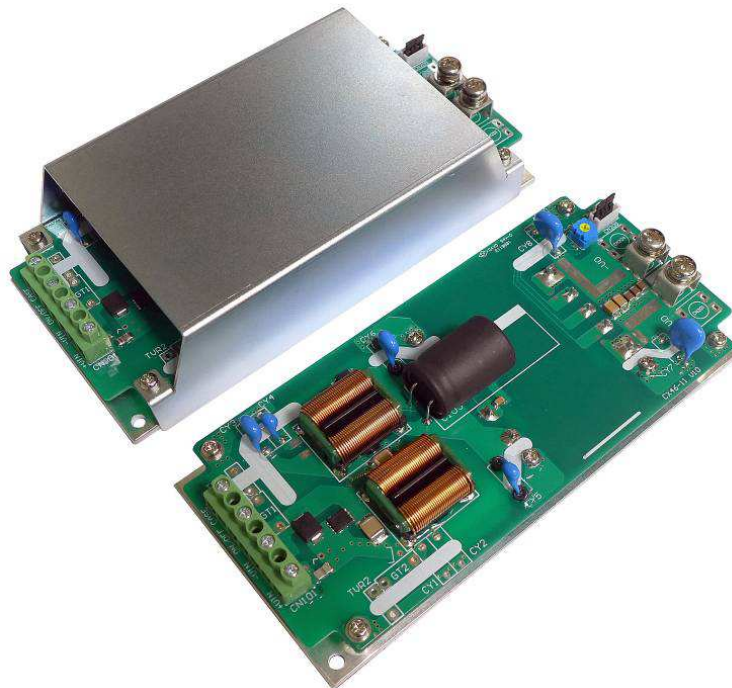

**CHASSIS MOUNT CHB300-300SXX-CMFC(D) Series  
Application Note V10 October 2018**

**ISOLATED DC-DC CONVERTER  
CHASSIS MOUNT  
CHB300-300SXX-CMFC(D) SERIES  
APPLICATION NOTE**



**Approved By:**

Department	Approved By	Checked By	Written By
Research and Development Department	Enoch	Astray	Astray
		Jacky	
Quality Assurance Department	Ryan	Benny	



# CHASSIS MOUNT CHB300-300SXX-CMFC(D) Series

## Application Note V10 October 2018

---

### Contents

1. Introduction .....	3
2. DC-DC Converter Features .....	3
3. Electrical Circuit Diagram .....	3
4. Terminal Block .....	3
5. Technical Specifications .....	4
6. Main Features and Functions .....	8
6.1 Operating Temperature Range .....	8
6.2 Output Voltage Adjustment .....	8
6.3 Over Current Protection .....	8
6.4 Output Over Voltage Protection .....	8
6.5 Remote On/Off .....	8
6.6 UVLO (Under Voltage Lock Out) .....	8
6.7 Over Temperature Protection .....	9
7. Applications .....	9
7.1 Connection for standard use .....	9
7.2 Convection Requirements for Cooling .....	9
7.3 Thermal Considerations .....	9
7.4 Derating .....	9
7.5 Power Derating .....	10
7.6 Hold up Time .....	12
7.7 Efficiency VS. Load .....	13
7.8 Test Set-Up .....	14
7.9 Output Voltage Adjustment .....	14
7.10 Output Remote Sensing .....	14
7.11 Output Ripple and Noise .....	15
7.12 Output Capacitance .....	15
7.13 Remote On/Off Circuit .....	15
8. Safety & EMC .....	16
8.1 Input Fusing and Safety Considerations .....	16
8.2 EMC Considerations .....	16
Part Number .....	19
10. Mechanical Specifications .....	19
10.1 Mechanical Outline Diagrams .....	19



# CHASSIS MOUNT CHB300-300SXX-CMFC(D) Series

## Application Note V10 October 2018

### 1. Introduction

The CHB300-300SXX-CMFC(D) series of chassis mountable DC-DC converters offers 300 watts of output power @ single output voltages of 5, 12, 24, 28, 48VDC. It has a wide (2:1) input voltage range of 180 to 425VDC (300VDC nominal) and 3000VAC reinforced isolation.

High efficiency up to 90%, allowing case operating temperature range of  $-40^{\circ}\text{C}$  to  $100^{\circ}\text{C}$ . An external heat sink is required to extend the full power range of the unit. Very low no load power consumption (10mA), an ideal solution for energy critical systems.

Built-in EMI EN55032 (EN55022) filter. Meet EN45545. The standard control functions include remote on/off (positive or negative) and +10%, -20% adjustable output voltage.

Fully protected against input UVLO (under voltage lock out), output over-current, output over-voltage and over-temperature and continuous short circuit conditions. CHB300-300SXX-CMFC(D) series is designed primarily for common applications of 300V nominal voltage and also suitable for distributed power architectures, telecommunications, battery operated equipment and industrial applications.

### 2. DC-DC Converter Features

- 300W Isolated Output
- Efficiency to 90%
- Low No Load Power Consumption
- Fixed Switching Frequency
- Regulated Outputs
- Over Temperature Protection
- Over Voltage/Current Protection
- Remote On/Off
- Continuous Short Circuit Protection
- Shock & Vibration Meet EN61373
- Safety Meets IEC60950 and IEC62368
- UL60950-1 2<sup>nd</sup> (Reinforced Insulation) Approval for DC Modules
- Fire & Smoke Meet EN45545-2
- Build-In EMI Filter
- Baseplate Cooled

### 3. Electrical Circuit Diagram

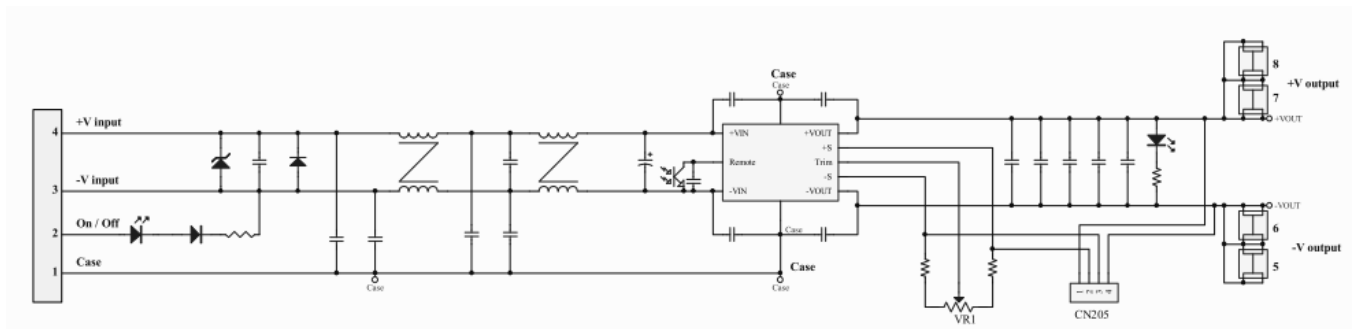

### 4. Terminal Block

Input and Output Terminal Block

PIN	Terminal Type	Screw Torque Value (Kgf-cm)	Suitable Electric Wire (AWG)	Current Rating (max.)
1~4	166-04P5 or Equivalent	5	18-12	12A
5~8	M5 Terminal Screw	25	12-10	30A



# CHASSIS MOUNT CHB300-300SXX-CMFC(D) Series

## Application Note V10 October 2018

### 5. Technical Specifications

(All specifications are typical at nominal input, full load at 25°C unless otherwise noted.)

#### ABSOLUTE MAXIMUM RATINGS

PARAMETER	NOTES and CONDITIONS	Device	Min.	Typical	Max.	Units
Input Voltage						
Continuous		All	-0.3		425	V <sub>dc</sub>
Transient	100ms	All			500	V <sub>dc</sub>
Operating Case Temperature		All	-40		100	°C
Storage Temperature		All	-40		105	°C
Isolation Voltage	1 minute; input/output	All			3000	V <sub>ac</sub>
	1 minute; input/case	All			2500	V <sub>ac</sub>
	1 minute; output/case	All			500	V <sub>ac</sub>

#### INPUT CHARACTERISTICS

PARAMETER	NOTES and CONDITIONS	Device	Min.	Typical	Max.	Units
Operating Input Voltage		All	180	300	425	V <sub>dc</sub>
Input Under Voltage Lockout						
Turn-On Voltage Threshold		All	165	170	175	V <sub>dc</sub>
Turn-Off Voltage Threshold		All	155.5	160.5	165.5	V <sub>dc</sub>
Lockout Hysteresis Voltage		All		9.5		V <sub>dc</sub>
Maximum Input Current	100% Load, V <sub>in</sub> =180V for All	All		2		A
No-Load Input Current		All		10		mA

#### OUTPUT CHARACTERISTICS

PARAMETER	NOTES and CONDITIONS	Device	Min.	Typical	Max.	Units
Output Voltage Set Point	V <sub>in</sub> =Nominal V <sub>in</sub> , I <sub>o</sub> = I <sub>o_max</sub> , T <sub>c</sub> =25°C	V <sub>o</sub> =5.0V	4.95	5	5.05	V <sub>dc</sub>
		V <sub>o</sub> =12V	11.88	12	12.12	
		V <sub>o</sub> =24V	23.76	24	24.24	
		V <sub>o</sub> =28V	27.72	28	28.28	
		V <sub>o</sub> =48V	47.52	48	48.48	
Output Voltage Regulation						
Load Regulation	I <sub>o</sub> =I <sub>o_min</sub> to I <sub>o_max</sub>	V <sub>o</sub> =5.0V			±0.5	%
		Other			±0.2	%
Line Regulation	V <sub>in</sub> =low line to high line	All			±0.2	%
Temperature Coefficient	T <sub>c</sub> =-40°C to 105°C	All			±0.02	%/°C



# CHASSIS MOUNT CHB300-300SXX-CMFC(D) Series

## Application Note V10 October 2018

PARAMETER	NOTES and CONDITIONS	Device	Min.	Typical	Max.	Units
Output Voltage Ripple and Noise (5Hz to 20MHz bandwidth)						
Peak-to-Peak	Full load, 1uF ceramic capacitor. See 7.11	Vo=5.0V			120	mV
		Vo=12V			150	
		Vo=24V			200	
		Vo=28V			200	
		Vo=48V			300	
RMS.		Vo=5.0V			60	mV
		Vo=12V			80	
		Vo=24V			100	
		Vo=28V			100	
		Vo=48V			150	
Operating Output Current Range		Vo=5.0V	0		60	A
		Vo=12V	0		25	
		Vo=24V	0		12.5	
		Vo=28V	0		10.7	
		Vo=48V	0		6.25	
Output DC Current Limit Inception	Hiccup Mode. Auto Recovery. See 6.3	All	105	120	140	%
Maximum Output Capacitance	Full load (resistive)	Vo=5.0V	0		10000	uF
		Vo=12V	0		10000	
		Vo=24V	0		6000	
		Vo=28V	0		6000	
		Vo=48V	0		3000	
Output Voltage Trim Range	$P_{out}$ =max rated power, Trim Adj. Range (By VR1), See 7.9	All	-20		+10	%
Output Over Voltage Protection	Limited Voltage, See 6.4	All	115	125	140	%

### DYNAMIC CHARACTERISTICS

PARAMETER	NOTES and CONDITIONS	Device	Min.	Typical	Max.	Units
Output Voltage Current Transient						
Error Band	75% to 100% of $I_{o\_max}$ step load change $d_i/d_t=0.1A/us$ (within 1% $V_{out}$ nominal)	All			±5	%
Recovery Time		All			250	us
Turn-On Delay and Rise Time	Full load (Constant resistive load)					
Turn-On Delay Time, From On/Off Control	$V_{on/off}$ to 10% $V_{o\_set}$	All		300		ms
Turn-On Delay Time, From Input	$V_{in\_min}$ to 10% $V_{o\_set}$	All		300		ms
Output Voltage Rise Time	10% $V_{o\_set}$ to 90% $V_{o\_set}$	All		50		ms

### EFFICIENCY

PARAMETER	NOTES and CONDITIONS	Device	Min.	Typical	Max.	Units
100% Load	$V_{in}=110V$ See 7.7	Vo=5.0V		88.5		%
		Vo=12V		87.5		
		Vo=24V		90		
		Vo=28V		90		
		Vo=48V		90		



# CHASSIS MOUNT CHB300-300SXX-CMFC(D) Series

## Application Note V10 October 2018

### ISOLATION CHARACTERISTICS

PARAMETER	NOTES and CONDITIONS	Device	Min.	Typical	Max.	Units
Isolation Voltage	1 minute; input/output	All			3000	V <sub>ac</sub>
	1 minute; input/case	All			2500	V <sub>ac</sub>
	1 minute; output/case	All			500	V <sub>ac</sub>
Isolation Resistance	Input / Output	All	100			MΩ

### FEATURE CHARACTERISTICS

PARAMETER	NOTES and CONDITIONS	Device	Min.	Typical	Max.	Units
Switching Frequency	Pulse wide modulation (PWM), Fixed	All	270	300	330	KHz
On/Off Control, Positive Remote On/Off logic, Refer to –Vin pin.						
Logic Low (Module Off)	V <sub>on/off</sub> at I <sub>on/off</sub> =0.0uA	All	0		1.2 or Open Circuit	V
Logic High (Module On)	V <sub>on/off</sub> at I <sub>on/off</sub> >0.3mA	All	3.5		12	V
On/Off Control, Negative Remote On/Off logic, Refer to –Vin pin						
Logic High (Module Off)	V <sub>on/off</sub> at I <sub>on/off</sub> >0.3mA	All	3.5		12	V
Logic Low (Module On)	V <sub>on/off</sub> at I <sub>on/off</sub> =0.0uA	All	0		1.2 or Open Circuit	V
On/Off Current (for both remote on/off logic)	I <sub>on/off</sub> at V <sub>on/off</sub> =3.5-12V	All	0.3		2.1	mA
Off Converter Input Current	Shutdown input idle current	All		3	5	mA
Over Temperature Shutdown	Aluminum base plate temperature See 6.7	All		105		°C
Over Temperature Recovery		All		95		°C



## CHASSIS MOUNT CHB300-300SXX-CMFC(D) Series Application Note V10 October 2018

### GENERAL SPECIFICATIONS

PARAMETER	NOTES and CONDITIONS	Device	Min.	Typical	Max.	Units
MTBF	$I_o=100\%$ of $I_{o\_max}$ ; MIL-HDBK - 217F_Notice 1, GB, 25°C	Vo=5.0V Vo=12V Vo=24V Vo=28V Vo=48V		360 443 569 537 550		K hours
Weight	CHB300-300SXX	-CMFC -CMFD		380 435		grams
Base plate Material	Aluminum					
Potting Material	UL 94V-0(DC MODULE)					
Shock/Vibration	Meets EN61373					
Humidity	95% RH max. Non Condensing					
Altitude	2000m Operating Altitude, 12000m Transport Altitude					
Thermal Shock	MIL-STD-810F					
Fire & Smoke	Meets EN45545-2					
EMI	Meets EN55032(EN55022), <b>see 8.2</b>				Class A	
ESD	Meets EN61000-4-2	Level 3: Air $\pm 8$ kV, Contact $\pm 6$ kV			Perf. Criteria A	
Radiated immunity	Meets EN61000-4-3	Level 3: 80~1000MHz, 20V/m			Perf. Criteria A	
Fast Transient	Meets EN61000-4-4	Level 3: On power input port, $\pm 2$ kV, <b>see 8.1</b>			Perf. Criteria A	
Surge	Meets EN61000-4-5	Level 4: Line to earth, Line to line, $\pm 2$ kV			Perf. Criteria A	
Conducted immunity	Meets EN61000-4-6	Level 3: 0.15~80MHz, 10Vrms			Perf. Criteria A	



# CHASSIS MOUNT CHB300-300SXX-CMFC(D) Series

## Application Note V10 October 2018

### 6. Main Features and Functions

#### 6.1 Operating Temperature Range

The CHB300-300SXX-CMFC(D) series converters can be operated within a wide case temperature range of  $-40^{\circ}\text{C}$  to  $100^{\circ}\text{C}$ . Consideration must be given to the derating curves when ascertaining maximum power that can be drawn from the converter. The maximum power drawn from chassis mount models is influenced by usual factors, such as:

- Input voltage range
- Output load current
- Forced air or natural convection
- Thermal Considerations

#### 6.2 Output Voltage Adjustment

**Section 7.10** describes in detail how to trim the output voltage with respect to its set point. The output voltage on all models is adjustable within the range of  $+10\%$  to  $-20\%$ .

#### 6.3 Over Current Protection

All models have internal over current and continuous short circuit protection. The unit operates normally once the fault condition is removed. At the point of current limit inception, the converter will go into hiccup mode protection.

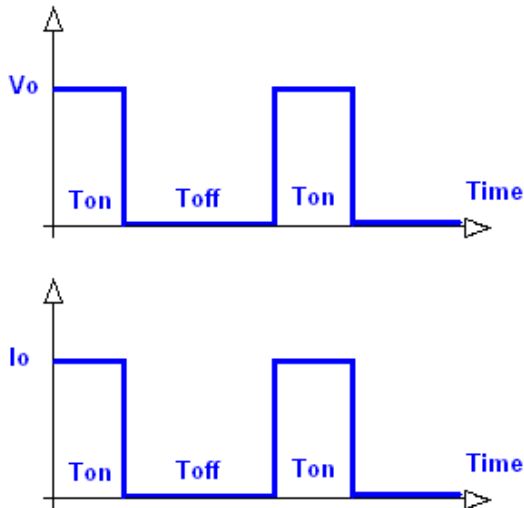

#### 6.4 Output Over Voltage Protection

The output over voltage protection consists of circuitry that internally limits the output voltage. If more accurate output over voltage protection is required then an external circuit can be used via the remote on/off pin.

**Note:** Please note that device inside the power supply might fail when voltage more than rate output voltage is applied to output pin. This could happen when the customer tests the over voltage protection of unit.

#### 6.5 Remote On/Off

The CHB300-300SXX-CMFC(D) series allows the user to switch the module on and off electronically with the remote on/off feature. All models are available in “positive logic” and “negative logic” (optional) versions. The converter turns on if the remote on/off pin is high ( $>3.5\text{Vdc}$  to  $12\text{Vdc}$ ). Setting the pin low ( $0$  to  $<1.2\text{Vdc}$  or open circuit) will turn the converter off. The signal level of the remote on/off input is defined with respect to ground. If leave the remote on/off pin open, the converter will be off.

Models with part number suffix “N” are the “negative logic” remote on/off version. The unit turns off if the remote on/off pin is high ( $>3.5\text{Vdc}$  to  $12\text{Vdc}$ ). The converter turns on if the on/off pin input is low ( $0$  to  $<1.2\text{Vdc}$  or open circuit). Note that the converter is off by default. **See 7.13**

Logic State ( Pin 2 )	Negative Logic	Positive Logic
Logic Low – 0 to 1.2Vdc or Open circuit	Module on	Module off
Logic High – 3.5 to 12Vdc	Module off	Module on

#### 6.6 UVLO (Under Voltage Lock Out)

Input under voltage lockout is standard on the CHB300-300SXX-CMFC(D) unit. The unit will shut down when the input voltage drops below a threshold, and the unit will operate when the input voltage goes above the upper threshold.

**CHB300-300SXX-CMFC(D)**  
**lin Vs Vin**

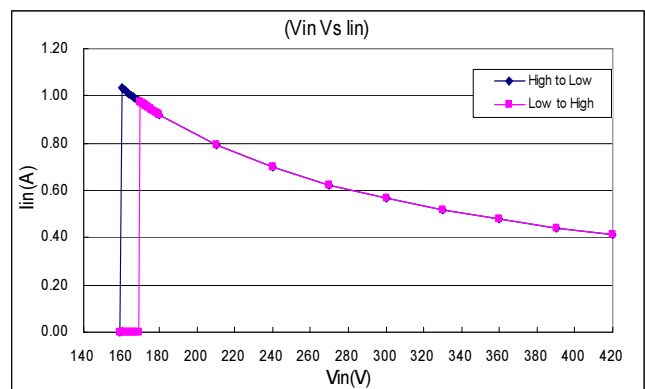





# CHASSIS MOUNT CHB300-300SXX-CMFC(D) Series Application Note V10 October 2018

## 6.7 Over Temperature Protection

These modules have an over temperature protection circuit to safeguard against thermal damage. Shutdown occurs with the maximum case reference temperature is exceeded. The module will restart when the case temperature falls below over temperature recovery threshold. Please measured at point A. (Measuring point A refer to the following figure)

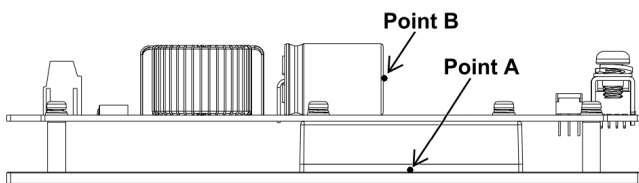
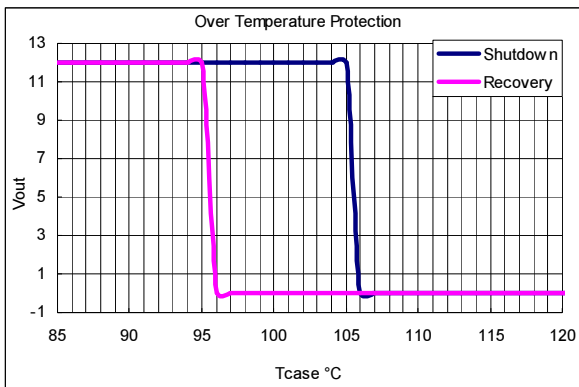

## 7. Applications

### 7.1 Connection for standard use

The connection for standard use is shown below. An external output capacitor (C1) is recommended to reduce output ripple and noise, output capacitor recommended 1 uF ceramic capacitor.

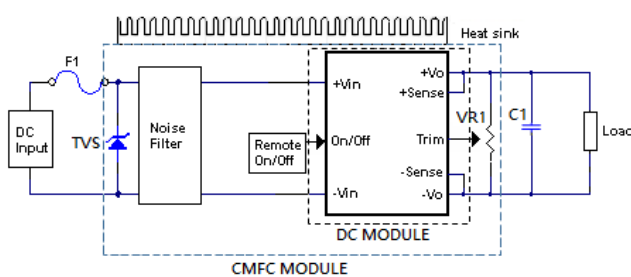

Symbol	Component	Reference
F1	Input fuse	Section 8.1
Noise Filter	Internal input noise filter	Section 8.2
Remote On/Off	External Remote On/Off control	Section 7.13
Trim	Internal output voltage adjustment by variable resistor	Section 7.9
Heat sink	External heat sink	Section 7.4/7.5
+Sense/-Sense	--	Section 7.10

### 7.2 Convection Requirements for Cooling

To predict the approximate cooling needed for the half brick module, refer to the power derating curves in section 7.5. These derating curves are approximations of the ambient temperatures and airflows required to keep the power module temperature below its maximum rating. Once the module is assembled in the actual system, the module's aluminum plate (point A) and aluminum capacitor (point B) temperature should be monitored to ensure it does not exceed 100°C.

### 7.3 Thermal Considerations

The power module operates in a variety of thermal environments; however, sufficient cooling should be provided to help ensure reliable operation of the unit. Heat is removed by conduction, convection, and radiation to the surrounding environment. The example is presented in section 7.5. The power output of the module should not be allowed to exceed rated power ( $V_{o\_set} \times I_{o\_max}$ ).

### 7.4 Derating

The following figures are ambient derating curve of CHB300-300SXX-CMFC(D) based on the aluminum base plate temperature. When operating the CHB300-300SXX-CMFC(D) series, proper derating or cooling is needed. The maximum case temperature under any operating condition should not exceed 100°C. (Measuring point A and measuring point B refer to the section 6.7)

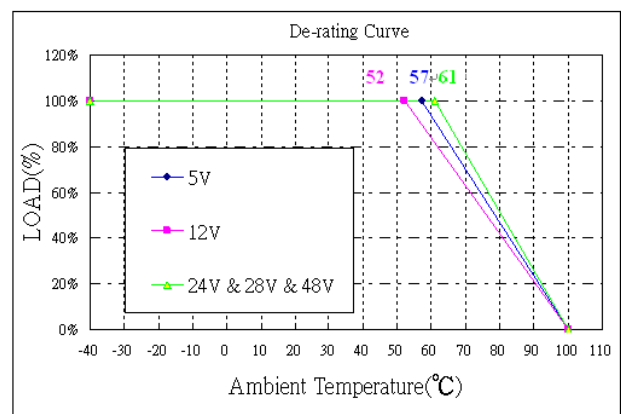

Ambient Derating Curves at Nominal Line, Full Load and Natural Convection, with heatsink (7.87x6.7x1.18inch)



# CHASSIS MOUNT CHB300-300SXX-CMFC(D) Series Application Note V10 October 2018

## 7.5 Power Derating

The operating case temperature range of CHB300-300SXX-CMFC(D) series is  $-40^{\circ}\text{C}$  to  $+100^{\circ}\text{C}$ . When operating the CHB300-300SXX-CMFC(D) series, proper derating or cooling is needed. The maximum case temperature under any operating condition should not exceed  $100^{\circ}\text{C}$ .

The following curve is the de-rating curve of CHB300-300SXX-CMFC(D) series with heat sink. The test condition refer to following figures.

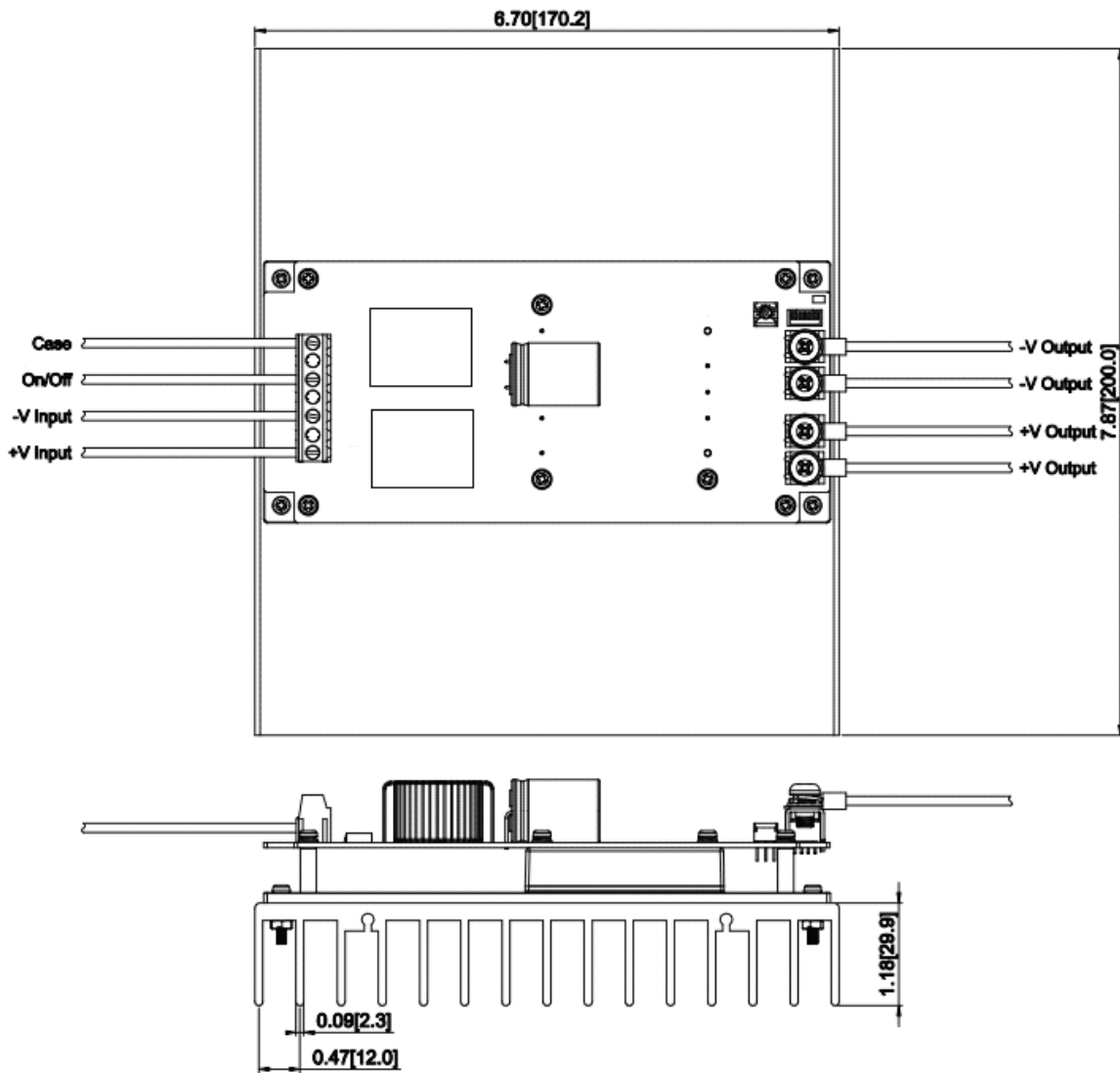



# CHASSIS MOUNT CHB300-300SXX-CMFC(D) Series Application Note V10 October 2018

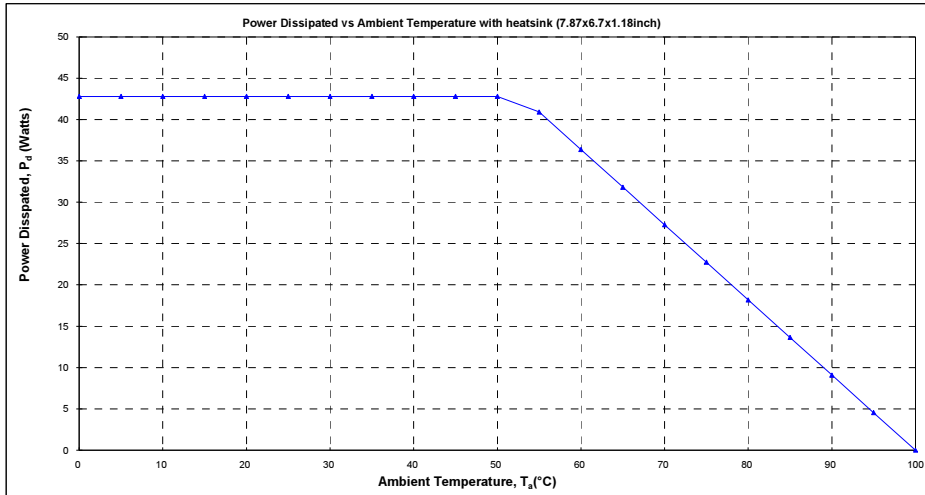

HEATSINK (7.87x6.7x1.18inch)	
AIR FLOW RATE	TYPICAL $R_{ca}$
Natural Convection 20ft./min. (0.1m/s)	1.1 °C/W

Example (with heat sink):

How to make a CHB300-300S24-CMFC operating at nominal line voltage, an output current of 12.5A, and a maximum ambient temperature of 55°C ?

**Solution:**

**Given:**

$$V_{in}=110V_{dc}, V_o=24V_{dc}, I_o=12.5A$$

**Determine Power dissipation ( $P_d$ ):**

$$P_d=P_i-P_o=P_o(1-\eta)/\eta$$

$$P_d=24.0 \times 12.5 \times (1-0.895)/0.895=35.2Watts$$

**Determine airflow:**

$$\text{Given: } P_d=35.2W \text{ and } T_a=55^\circ C$$

**Check above Power de-rating curve:**

Heat sink with 7.87x6.7x1.18inch

**Verify:**

$$\text{Maximum temperature rise is } \Delta T = P_d \times R_{ca}=35.2 \times 1.1=38.72^\circ C$$

$$\text{Maximum case temperature is } T_c=T_a+\Delta T=93.72^\circ C < 100^\circ C$$

**Where:**

The  $R_{ca}$  is thermal resistance from case to ambient environment.

$T_a$  is ambient temperature and  $T_c$  is case temperature.



# CHASSIS MOUNT CHB300-300SXX-CMFC(D) Series Application Note V10 October 2018

## 7.6 Hold up Time

Hold up time is defined as the duration of time that DC/DC converter output will remain active following a loss of input power. The test condition and test curve refer to below.

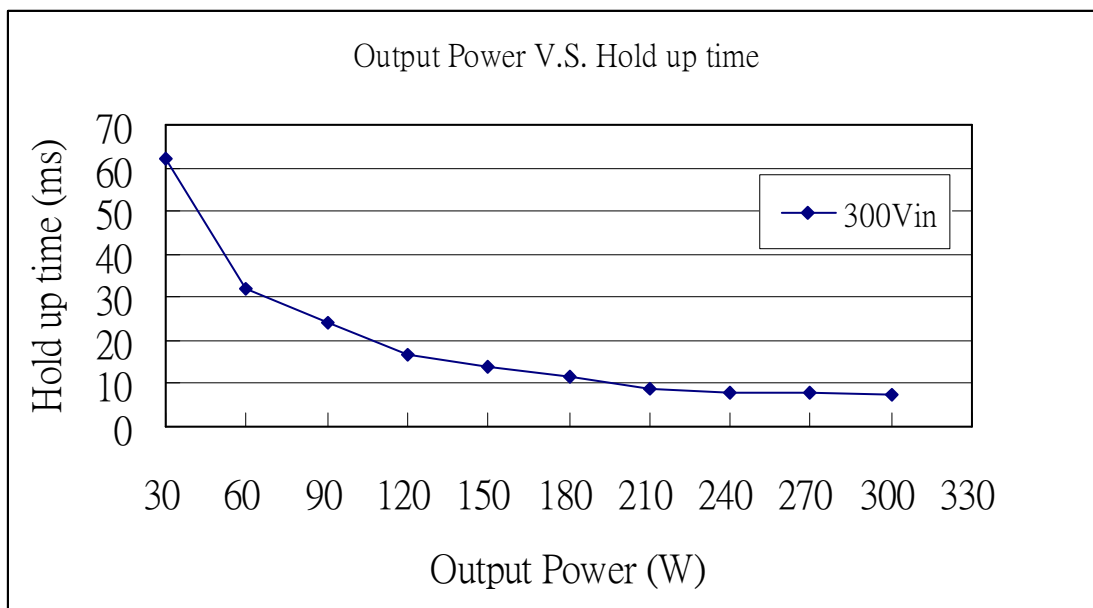
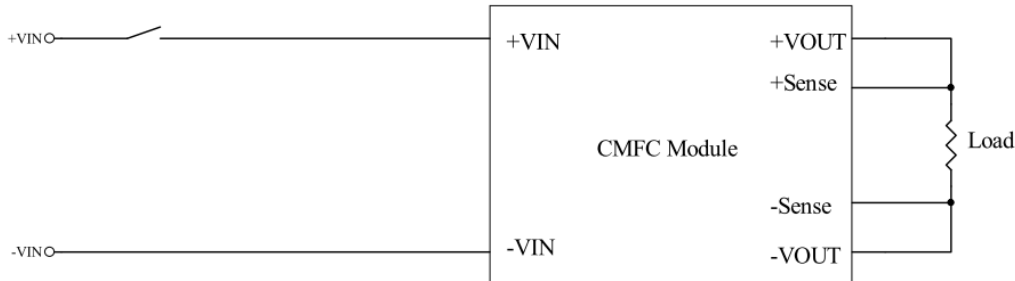

To meet power supply interruptions, an external circuit is required, shown below.

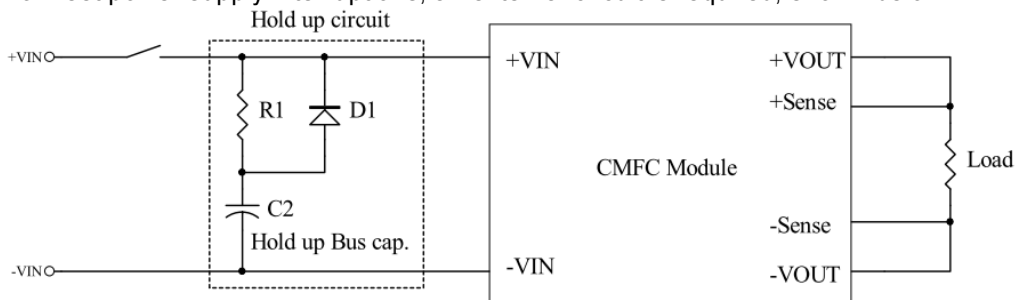

D1:600V/5A  
R1:100Ω/10W

C2	300Vin
<b>Hold up time for 10ms</b>	68uF
<b>Hold up time for 30ms</b>	330uF



# CHASSIS MOUNT CHB300-300SXX-CMFC(D) Series Application Note V10 October 2018

## 7.7 Efficiency VS. Load

### CHB300-300S05-CMFC(D)

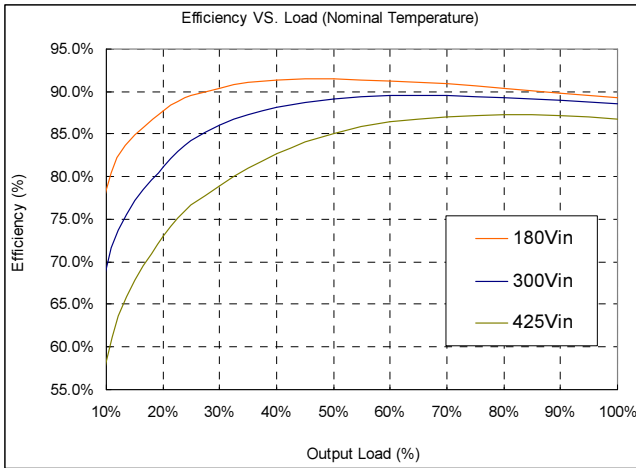

### CHB300-300S12-CMFC(D)

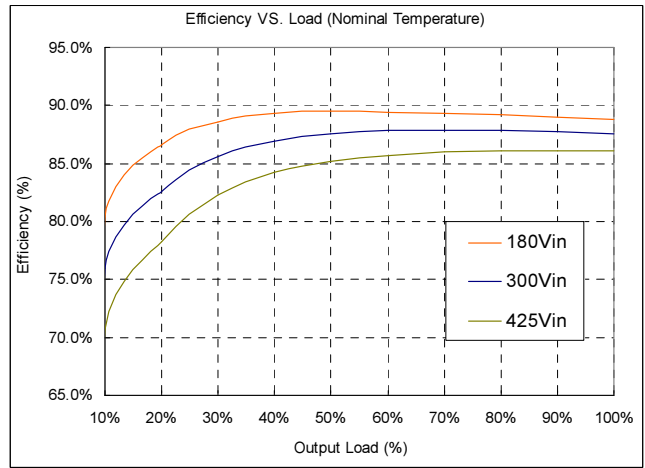

### CHB300-300S24-CMFC(D)

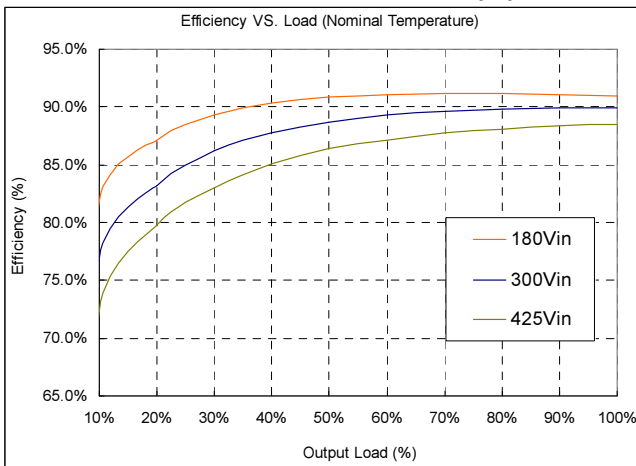

### CHB300-300S28-CMFC(D)

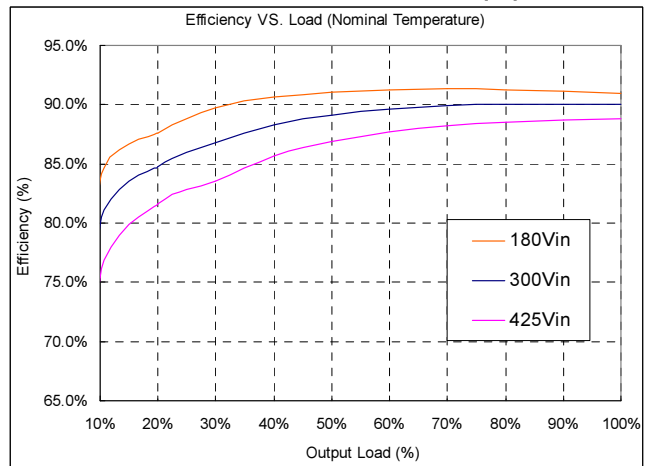

### CHB300-300S48-CMFC(D)

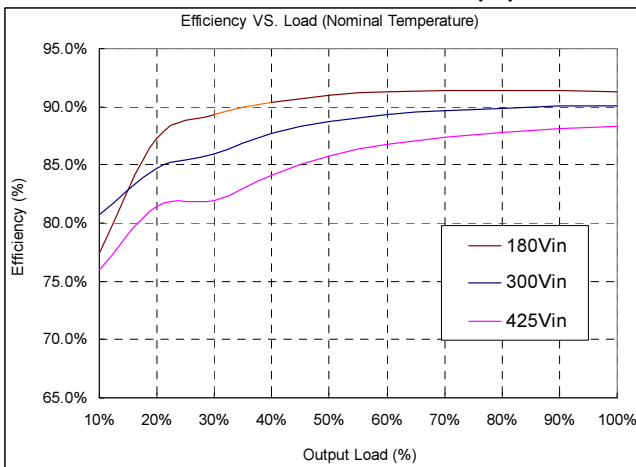



# CHASSIS MOUNT CHB300-300SXX-CMFC(D) Series Application Note V10 October 2018

## 7.8 Test Set-Up

The basic test set-up to measure parameters such as efficiency and load regulation is shown below. When testing the modules under any transient conditions please ensure that the transient response of the source is sufficient to power the equipment under test. We can calculate:

- Efficiency
- Load regulation and line regulation.

The value of efficiency is defined as:

$$\eta = \frac{V_o \times I_o}{V_{in} \times I_{in}} \times 100\%$$

Where:

- $V_o$  is output voltage,
- $I_o$  is output current,
- $V_{in}$  is input voltage,
- $I_{in}$  is input current.

The value of load regulation is defined as:

$$Load.reg = \frac{V_{FL} - V_{NL}}{V_{NL}} \times 100\%$$

Where:

- $V_{FL}$  is the output voltage at full load.
- $V_{NL}$  is the output voltage at no load.

The value of line regulation is defined as:

$$Line.reg = \frac{V_{HL} - V_{LL}}{V_{LL}} \times 100\%$$

Where:  $V_{HL}$  is the output voltage of maximum input voltage at full load.  $V_{LL}$  is the output voltage of minimum input voltage at full load.

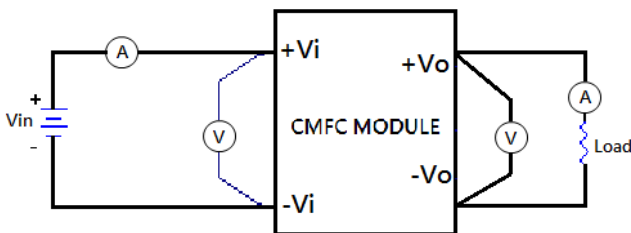

CHB300-300SXX-CMFC(D) Series Test Setup

## 7.9 Output Voltage Adjustment

Output may be externally trimmed (-20% ~ +10%) with a variable resistance as shown. Output voltage can be adjusted by internal variable resistor. Turning internal variable resistor clockwise reduces the output voltage and counterclockwise increases the output voltage.

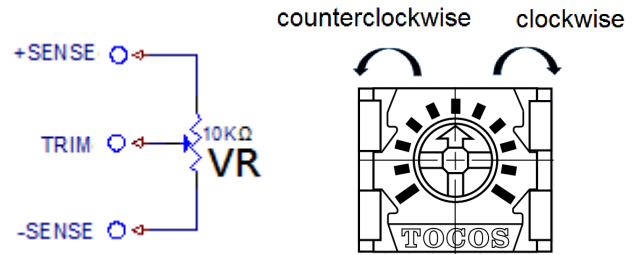

## 7.10 Output Remote Sensing

The CHB300-300SXX-CMFC(D) series converter has the capability to remotely sense both lines of its output. This feature moves the effective output voltage regulation point from the output of the unit to the point of connection of the remote sense pins. This feature automatically adjusts the real output voltage of the CHB300-300SXX-CMFC(D) series in order to compensate for voltage drops in distribution and maintain a regulated voltage at the point of load. The remote-sense voltage range is:

$$[(+V_{out}) - (-V_{out})] - [(+Sense) - (-Sense)] \leq +10\% / -20\% \text{ of } V_{o\_nominal}$$

When remote sensing is used, please remove the jumper of CN205. When remote sense is in use, the sense should be connected by twisted-pair wire or shield wire. If the sensing patterns short, heavy current flows and the pattern may be damaged. Output voltage might become unstable because of impedance of wiring and load condition when length of wire is exceeding 400mm. This is shown in the schematic below.

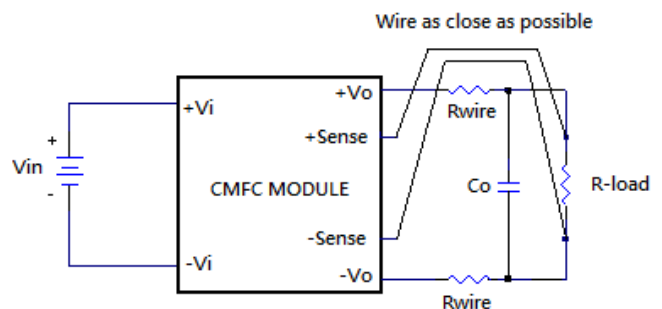

When the CHB300-300SXX-CMFC(D) module are shipped from a factory, they come with a dedicated jumper being mounted on CN205. If the remote sense feature is not to be used, the sense pins should be connected locally. The +Sense pin should be connected to the +Vout pin at the module and the -Sense pin should be connected to the -Vout pin at the module. Wire between +Sense and +Vout and between -Sense and -Vout as short as possible. Loop wiring should be avoided. The converter might become unstable by noise coming from poor wiring. This is shown in the schematic below.



# CHASSIS MOUNT CHB300-300SXX-CMFC(D) Series Application Note V10 October 2018

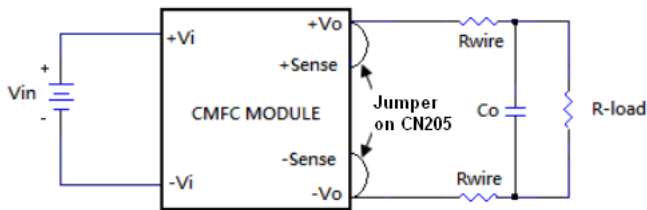

**Note:** Although the output voltage can be varied (increased or decreased) by both remote sense and trim, the maximum variation for the output voltage is the larger of the two values not the sum of the values. The output power delivered by the module is defined as the voltage at the output terminals multiplied by the output current. Using remote sense and trim can cause the output voltage to increase and consequently increase the power output of the module if output current remains unchanged. Always ensure that the output power of the module remains at or below the maximum rated power. Also be aware that if  $V_{o,set}$  is below nominal value,  $P_{out,max}$  will also decrease accordingly because  $I_{o,max}$  is an absolute limit. Thus,  $P_{out,max} = V_{o,set} \times I_{o,max}$  is also an absolute limit.

## 7.11 Output Ripple and Noise

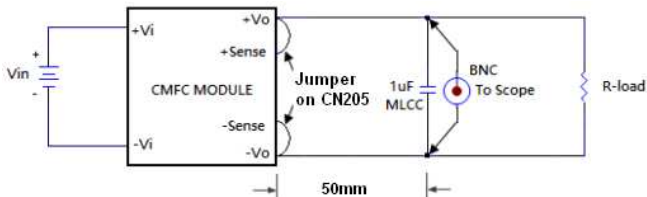

Output ripple and noise measured with 1uF ceramic capacitors across output. A 20 MHz bandwidth oscilloscope is normally used for the measurement.

The conventional ground clip on an oscilloscope probe should never be used in this kind of measurement. This clip, when placed in a field of radiated high frequency energy, acts as an antenna or inductive pickup loop, creating an extraneous voltage that is not part of the output noise of the converter.

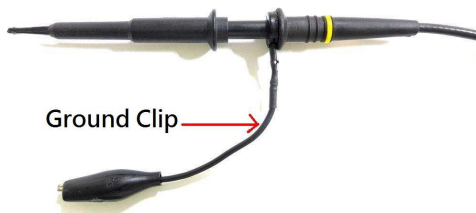

Another method is shown in below, in case of coaxial-cable/BNC is not available. The noise pickup is eliminated by pressing scope probe ground ring directly against the -Vout terminal while the tip contacts the +Vout terminal. This makes the shortest possible connection across the output terminals.

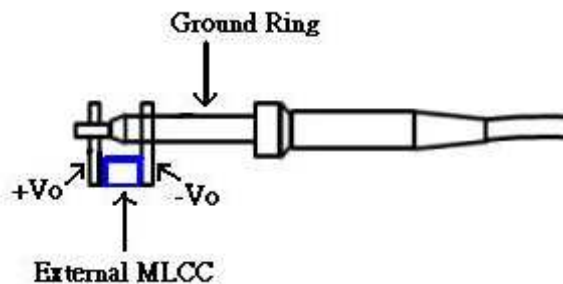

## 7.12 Output Capacitance

The CHB300-300SXX-CMFC(D) series converters provide unconditional stability with or without external capacitors. For good transient response, low ESR output capacitors should be located close to the point of load (<100mm). PCB design emphasizes low resistance and inductance tracks in consideration of high current applications. Output capacitors with their associated ESR values have an impact on loop stability and bandwidth. Cincon's converters are designed to work with load capacitance to see technical specifications.

## 7.13 Remote On/Off Circuit

The converter remote on/off circuit built-in on input side. The ground pin of input side remote on/off circuit is -Vin pin.

**Refer to 6.5** for more details.

When on/off is at high level, a current of 10mA max will sink in. Avoid the reverse polarity input voltage. It may break the power supply.

Connection examples see below.

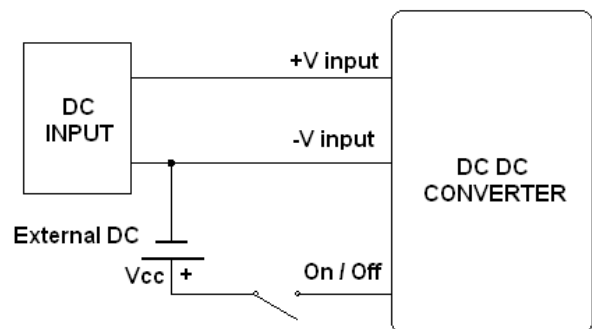

Remote On/Off Connection Example





# CHASSIS MOUNT CHB300-300SXX-CMFC(D) Series Application Note V10 October 2018

## 8. Safety & EMC

### 8.1 Input Fusing and Safety Considerations

The CHB300-300SXX-CMFC(D) series converters included internal fuse for maximum safety and system protection. CHB300-300SXX-CMFC(D) module have a transient voltage suppressor diode (TVS) across the input terminal to protect the unit against surge or spike voltage and input reverse voltage (as shown).

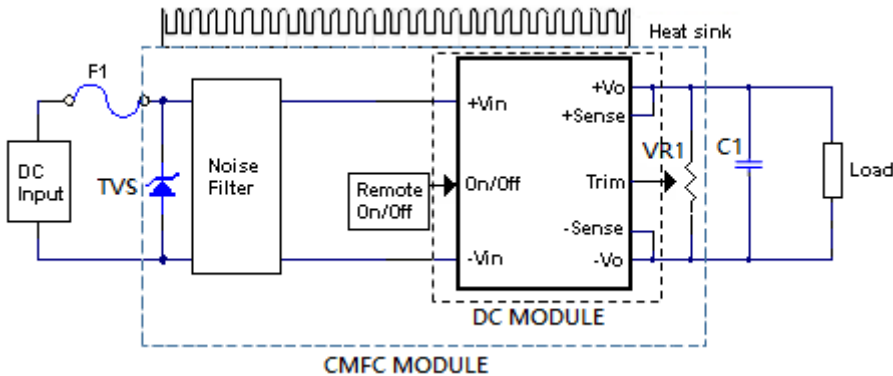

### 8.2 EMC Considerations

EMI Test standard: EN55032 (EN55022) Class A Conducted & Radiated Emission  
Test Condition: Input Voltage: 300Vdc, Output Load: Full Load

(1) EMI meet EN55032 (EN55022) Class A:

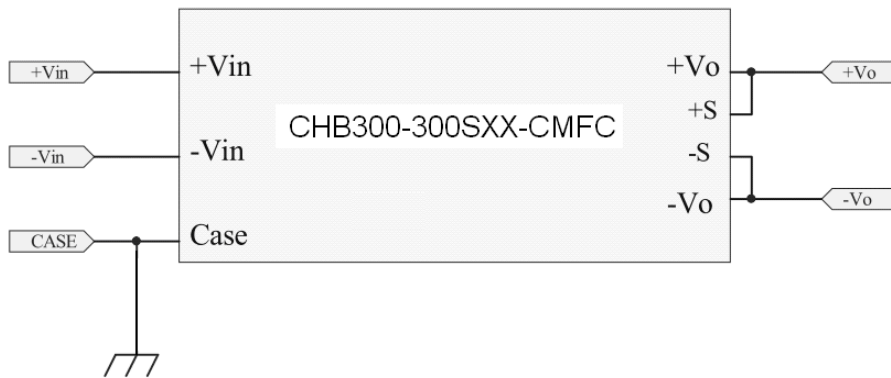

Connection circuit for EMI testing





# CHASSIS MOUNT CHB300-300SXX-CMFC(D) Series Application Note V10 October 2018

## Conducted Emission(Input): CHB300-300S05-CMFC Line

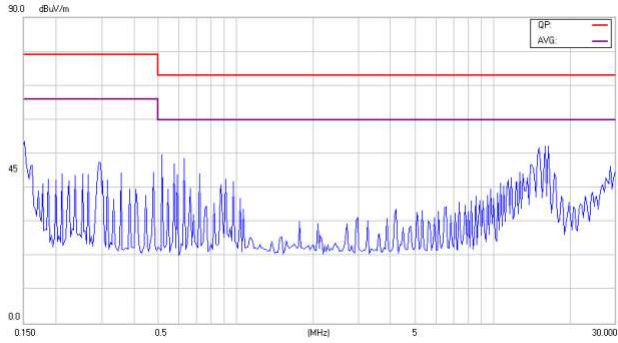

## Neutral

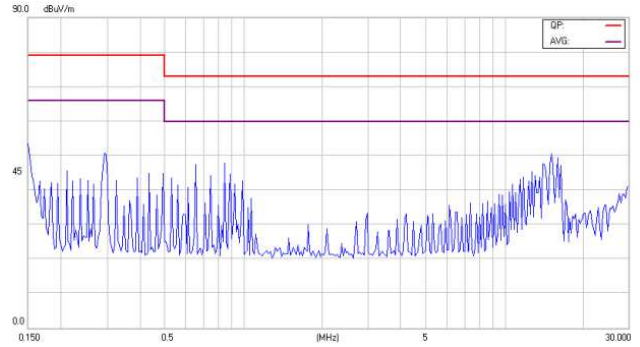

## CHB300-300S12-CMFC Line

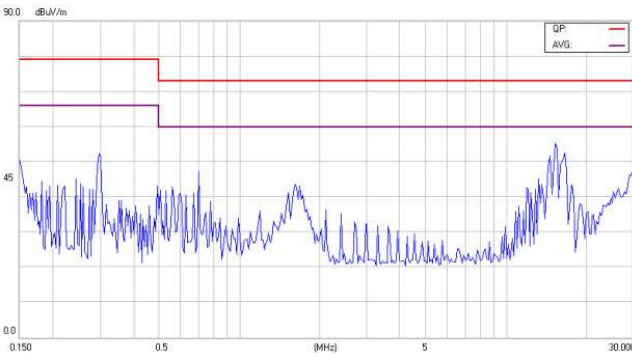

## Neutral

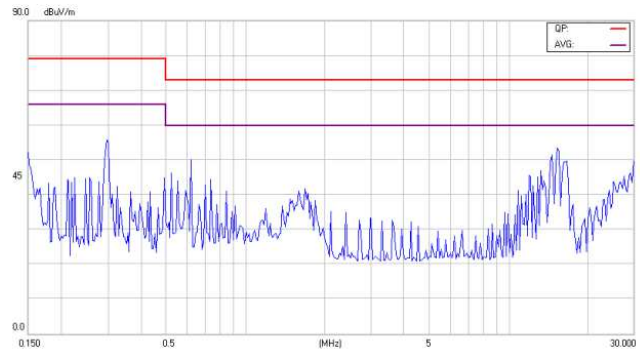

## CHB300-300S24-CMFC Line

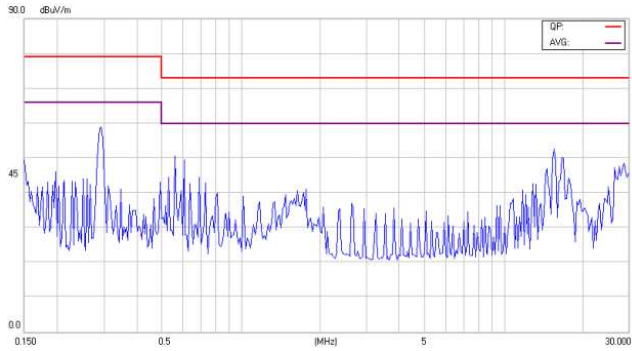

## Neutral

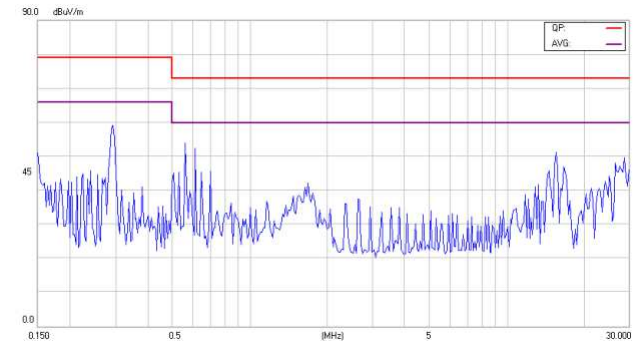

## CHB300-300S28-CMFC Line

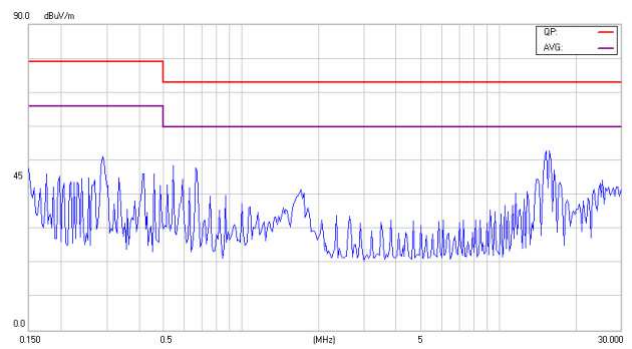

## Neutral

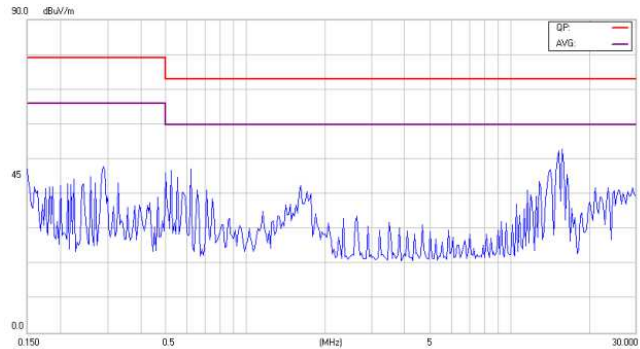



# CHASSIS MOUNT CHB300-300SXX-CMFC(D) Series Application Note V10 October 2018

CHB300-300S48-CMFC  
Line

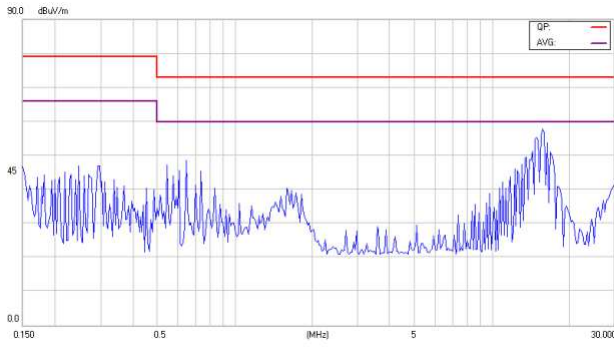

Neutral

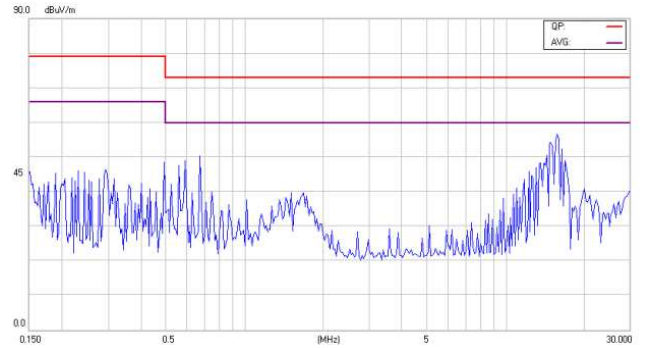



# CHASSIS MOUNT CHB300-300SXX-CMFC(D) Series

## Application Note V10 October 2018

### Part Number

Format: CHB300 – III OXXL-YYYY

Parameter	Series	Nominal Input Voltage	Number of Outputs	Output Voltage	Remote On/Off Logic	Chassis Mount Type	
Symbol	CHB300-	III	O	XX	L	YYY	Z (Option)
Value	CHB300-	300: 300 Volts	S: Single	05: 5.0 Volts 12: 12 Volts 24: 24 Volts 28: 28 Volts 48: 48 Volts	None: Positive N: Negative	CMF Chassis Mount Built in Filter	C: Open Frame with Cover D:

## 10. Mechanical Specifications

### 10.1 Mechanical Outline Diagrams

All Dimensions In Inches (mm)  
Tolerance Inches: X.XX= ±0.02 , X.XXX= ±0.010  
Millimeters: X.X= ±0.5 , X.XX=±0.25

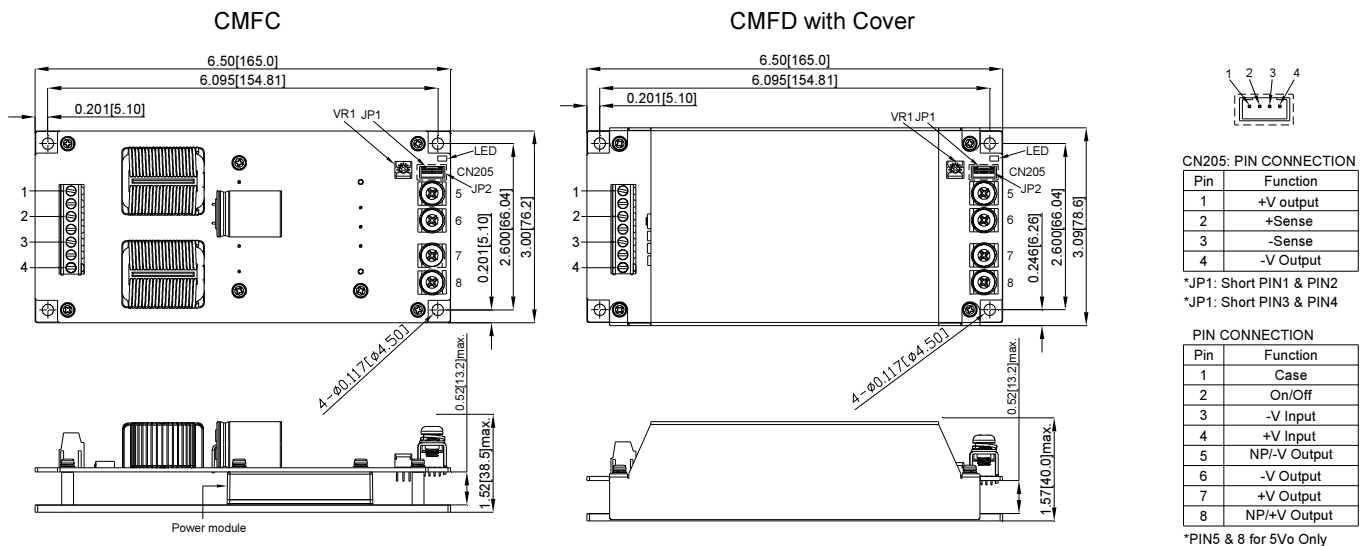

CHB300-300SXX-CMFC(D) Mechanical Outline Diagram

### CINCON ELECTRONICS CO., LTD.

#### Headquarters:

14F, No.306, Sec.4, Hsin Yi Rd.  
Taipei, Taiwan  
Tel: 886-2-27086210  
Fax: 886-2-27029852  
E-mail: [support@cincon.com.tw](mailto:support@cincon.com.tw)  
Web Site: <http://www.cincon.com>

#### Factory:

No. 8-1, Fu Kung Rd.  
Fu Hsing Industrial Park  
Fu Hsing Hsiang,  
ChangHua Hsien, Taiwan  
Tel: 886-4-7690261  
Fax: 886-4-7698031

#### Cincon North America:

1655Mesa Verde Ave. Ste 180  
Ventura, CA93003  
Tel: 805-639-3350  
Fax: 805-639-4101  
E-mail: [info@cincon.com](mailto:info@cincon.com)