

Non-isolated DC-DC converter
Fixed input voltage and regulated adjustable single high voltage output



Patent Protection

RoHS



FEATURES

- Ultra compact size, 15.00 x 15.00 x 18.00 mm
- No-load input current as low as 20mA
- Continuous high voltage output with linear adjustable function
- Output ripple as low as 30mV
- Output voltage with high stability, low time coefficient and temperature coefficient
- Operating ambient temperature range: -40°C to +85°C
- Input reverse polarity protection
- Output short-circuit protection, over-current protection
- EMI meet CISPR32/EN55032 CLASS A/B
- Meet EN62368 standard

HO1-P(N)1201-0.6B series offer 0.72W of output, with operating ambient temperature range -40°C to +85°C, input reverse polarity protection, output short circuit protection, over-current protection, ultra compact size, low ripple, low time coefficient and temperature coefficient, which are specifically designed for applications in board power systems where high voltages are required and output ripple requirements are high and output voltage stability is critical. They are widely used in fields such as photomultiplier tubes, mass spectrum, light spectrum, electron beam, ion beam, avalanche diodes.

Selection Guide

Certification	Part No.	Input Voltage (VDC)	Input Current ^① (mA) Full load/No-load		Output Voltage (VDC)			Output Current (mA) Max./Min.
		Nominal (Range)	Typ.	Max.	Nominal ^②	Range	Guaranteed range	
--	HO1-P1201-0.6B	5 (4.5-5.5)	230/20	250/30	1200	0~+1200	+200~+1200	0.6/0
	HO1-N1201-0.6B		230/20	250/30	-1200	0~-1200	-1200~-200	0.6/0

Note:
① At the nominal input voltage 5V and nominal output voltage 1200V or -1200V;
② For HO1-P(N)1201-0.6B when the Vadj control voltage is equal to 1.2VDC (Typ.), the output voltage can be nominal output voltage, the relationship curve between output voltage and control voltage is shown in Fig.4.

Input Specifications

Item	Operating Conditions	Min.	Typ.	Max.	Unit
Input Current (full load / no-load)	Normal temperature, nominal input voltage, nominal output voltage	--	230/20	250/30	mA
Reflected Ripple Current ^①		--	30	--	mA
Surge Voltage (1sec. max.)		--	--	9	VDC
Input Filter Type		Capacitance filter			
Hot Plug		Unavailable			
Input Reverse Polarity protection	The voltage between Vin and GND	-9	--	0	VDC

Note:
① Refer to DC-DC Converter Application Notes for detailed description of reflected ripple current test method.

Output Specifications

Item	Operating Conditions	Min.	Typ.	Max.	Unit
Adjust-point Tolerance	Output voltage guaranteed range, see Fig.4	--	±1	±2	%
Reference Voltage Accuracy	0%-100% load	--	±1	±2	
Linear Regulation	Input voltage range, nominal output voltage, full load	--	±0.01	--	
Load Regulation	Nominal input voltage, nominal output voltage, 10%-100% load	--	±0.01	--	
On/Off Overshoot	Input voltage range, nominal output voltage, 0%-100% load	--	--	3	%Vo
Time Coefficient	Nominal input voltage, nominal output voltage, full load, after warming up for 30 minutes	--	±0.001	±0.003	%/Hr
Temperature Coefficient	Nominal input voltage, nominal output voltage, full load	--	±100	±200	PPM/°C
Ripple & Noise ^①	20MHz bandwidth, nominal input voltage, 0%-100% load	--	30	--	mV p-p

Over-current Protection	Input voltage range	105	115	150	%Io
Short-circuit Protection	Input voltage range	Constant current mode, continuous			
Vadj (Output Voltage Adjustment Function)	Input voltage range	0-1.2V linear adjustment, set the product output voltage by setting the voltage of Vadj pin			
Note: ① Please refer to Fig.2 for the test method of ripple and noise, the product is working by the linear power source.					

General Specifications

Item	Operating Conditions	Min.	Typ.	Max.	Unit
Operating Temperature	See Fig. 1	-40	--	+85	°C
Storage Temperature		-40	--	+85	
Storage Humidity	Non-condensing	5	--	85	%RH
Pin Soldering Resistance Temperature	Wave-soldering, 10 seconds	--	--	260	°C
	Soldering spot is 1.5mm away from case for 10 seconds	--	--	300	
Pollution level		Grade 2, used in applications where no pollution conduction occurs but temporary pollution conduction may occur due to accidental condensation, such as office environment.			
Vibration		10-150Hz, 5G, 0.75mm. along X, Y and Z			
Switching Frequency	Nominal input voltage, full load	--	150	--	KHz
Altitude		Altitude: ≤2000m			
MTBF	MIL-HDBK-217F@25°C	1000	--	--	K hours

Mechanical Specifications

Case Material	Black plastic; flame-retardant and heat-resistant (UL94-V0)
Dimensions	15.00 x 15.00 x 18.00 mm
Weight	7.0g (Typ.)
Cooling Method	Free air convection

Electromagnetic Compatibility (EMC)

Emissions	CE	CISPR32/EN55032 CLASS A (see Fig.5-② for recommended circuit) CISPR32/EN55032 CLASS B (see Fig.6-② for recommended circuit)
	RE	CISPR32/EN55032 CLASS B (without extra components)
Immunity	ESD	IEC/EN61000-4-2 Contact ±4KV perf. Criteria B
	RS	IEC/EN61000-4-3 10V/m perf. Criteria B
	EFT	IEC/EN61000-4-4 100KHz ±2KV (see Fig.5-① for recommended circuit) perf. Criteria B
	Surge	IEC/EN61000-4-5 line to line ±2KV (see Fig.5-① for recommended circuit) perf. Criteria B
	CS	IEC/EN61000-4-6 3 Vr.m.s perf. Criteria B

Product Characteristic Curve

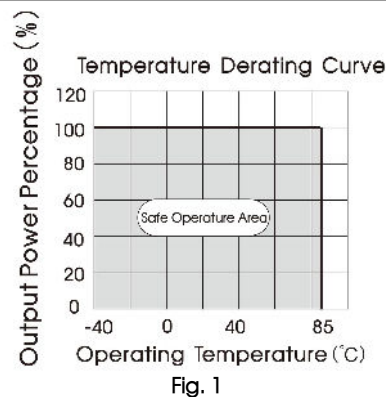

Design Reference

1. Ripple & Noise testing compliance circuit

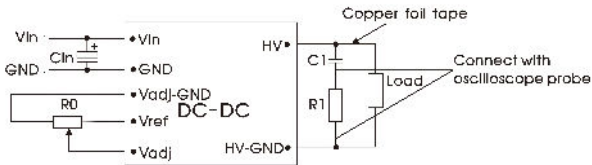

Fig. 2

Parameter description:

Cin	100 μ F/50V
R0	Adjustable resistance $\geq 10K \Omega$
R1	1K Ω /2W resistance
C1	4.7nF/2000V

2. Typical application

The output voltage of the product can be adjusted by an external circuit. There are two adjustment methods, as shown in Fig.3. The relationship curve between output voltage of the product and control voltage is shown in Fig.4. Output ripple can be further reduced by connect the RC filter on the output end of the product.

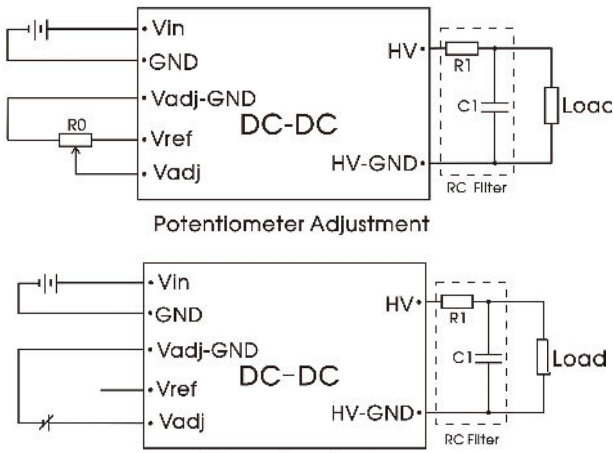

External control voltage regulation
Fig.3

Parameter description:

R0	Adjustable resistance $\geq 10K \Omega$
R1	2K Ω
C1	4.7nF/2000V
Vref	1.24VDC
Control voltage	0-1.2VDC

Output Voltage-Control Voltage relationship Curve

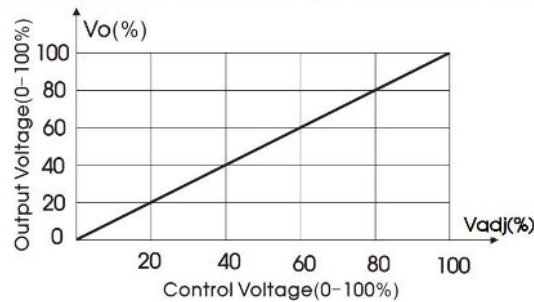

(Note: 100% Vadj is equal to 1.2VDC (Typ.);

Fig.4 The relationship curve of output voltage and control voltage

3. EMC compliance circuit

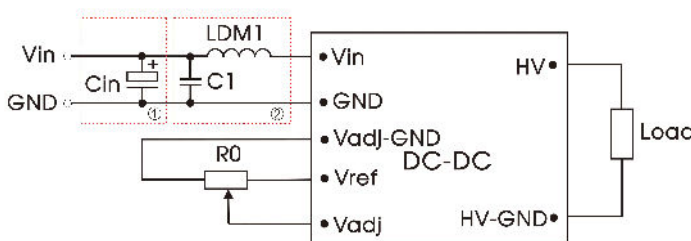
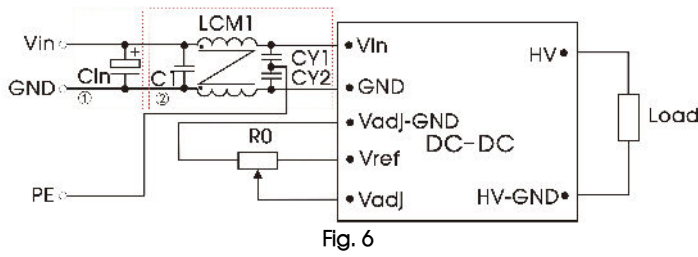

Fig. 5

Parameter description:

Cin	4700 μ F/50V Aluminum electrolytic capacitor
C1	10 μ F/50V MLCC capacitor
LDM1	6.8 μ H
R0	Adjustable resistance $\geq 10K \Omega$

Parameter description:



Cin	4700μF/50V Aluminum electrolytic capacitor
C1	22uF/50V MLCC capacitor
LCM1	4.7mH (Mornsun common mode filter recommended, FL2D-30-472)
CY1, CY2	2.2nF Y2 capacitor
R0	Adjustable resistance ≥ 10KΩ

4. For additional information please refer to DC-DC converter application notes on www.mornsun.cn

Dimensions and Recommended Layout

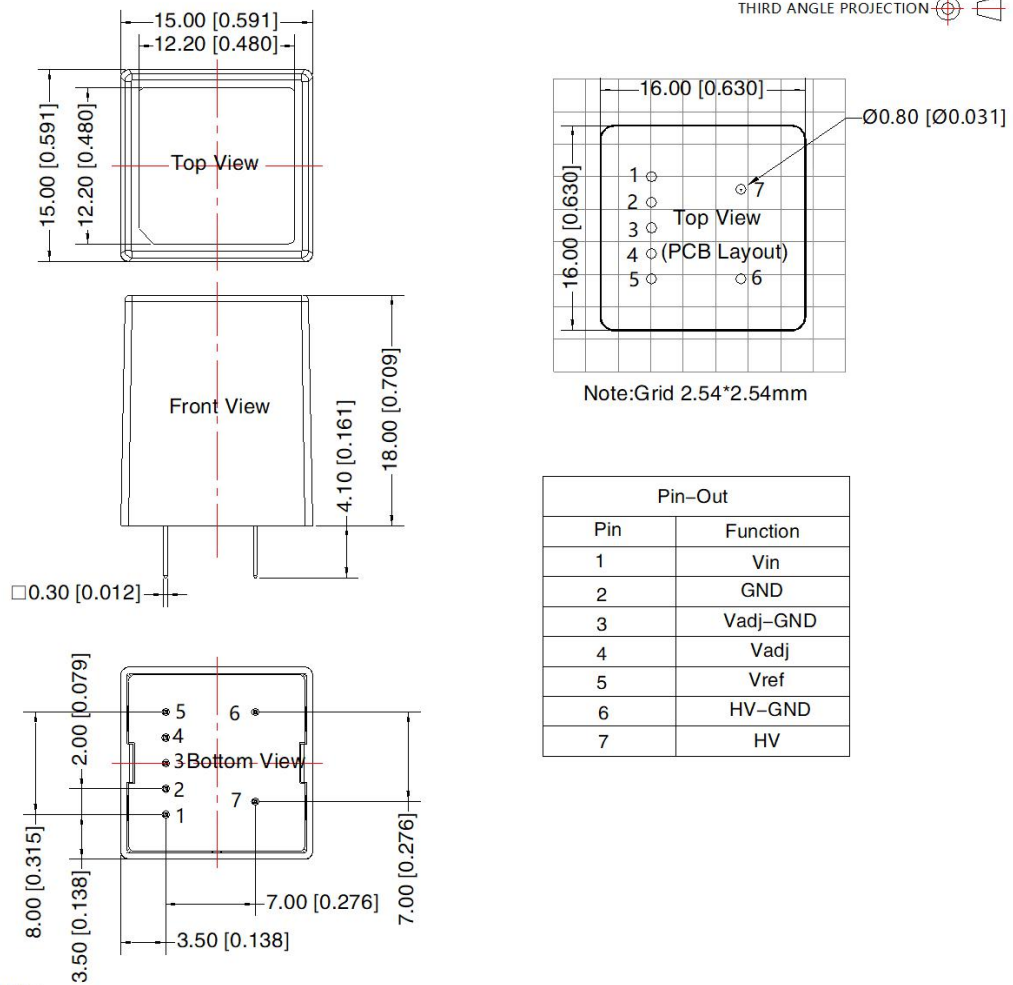

Pin-Out	
Pin	Function
1	Vin
2	GND
3	Vadj-GND
4	Vadj
5	Vref
6	HV-GND
7	HV

Note:
Unit: mm[inch]
Pin section tolerances: ± 0.10[± 0.004]
General tolerances: ± 0.50[± 0.020]

Notes:

1. For additional information on Product Packaging please refer to www.mornsun-power.com. Packaging bag number: 58210121;
2. If the product is not operated within the required load range, the product performance cannot be guaranteed to comply with all parameters in the datasheet;
3. Unless otherwise specified, parameters in this datasheet were measured under the conditions of $T_a=25^{\circ}\text{C}$, humidity<75%RH with nominal input voltage, nominal output voltage and rated output load;
4. All index testing methods in this datasheet are based on our company corporate standards;
5. We can provide product customization service, please contact our technicians directly for specific information;
6. Products are related to laws and regulations: see "Features" and "EMC";
7. Our products shall be classified according to ISO14001 and related environmental laws and regulations, and shall be handled by qualified units.

Mornsun Guangzhou Science & Technology Co., Ltd.

Address: No. 5, Kehui St. 1, Kehui Development Center, Science Ave., Guangzhou Science City, Huangpu District, Guangzhou, P. R. China
Tel: 86-20-38601850 Fax: 86-20-38601272 E-mail: info@mornsun.cn www.mornsun-power.com