

Wide input voltage, non-isolated and regulated single output



FEATURES

- High efficiency up to 95%
- No-load input current as low as 0.2mA
- Operating ambient temperature range:-40°C to +85°C
- Support the negative output
- Output short circuit protection
- Pin compatible with LM78XX series linear regulators
- EN62368 approved

K78xxW-500R3 series are high efficiency switching regulators and ideal substitutes of LM78xx series three-terminal linear regulators. The product is featured with high efficiency, low loss, short circuit protection, support the negative output and no heat sink requirement. These products are widely used in applications such as industrial control, instrumentation and electric power.

Selection Guide

Certification	Part Number	Input Voltage (VDC)	Output		Full Load Efficiency(%) typ. Vin Min. / Vin Max.	Max. Capacitive Load (μF)
		Nominal (Range)	Voltage (VDC)	Max. Output Current (mA)		
CE	K7803W-500R3	24 (4.75-36)	3.3	500	86/80	680
	K7805W-500R3	24 (6.5-36)	5	500	90/84	680
		12 (7-31)	-5	-300	80/81	330
	K7809W-500R3	24 (12-36)	9	500	93/90	680
	K7812W-500R3	24 (15-36)	12	500	94/91	680
		12 (8-24)	-12	-150	84/85	330
	K7815W-500R3	24 (19-36)	15	500	95/93	680
		12 (8-21)	-15	-150	85/87	330

Note: When the input voltage exceeds 30VDC, the input needs to be connected with an electrolytic capacitor of 22μF/50V to prevent the module from being damaged by voltage spikes.

Input Specifications

Item	Operating Conditions	Min.	Typ.	Max.	Unit
No-load Input Current	Positive output	--	0.2	1.5	mA
Input Reverse Polarity		Avoid / Not protected			
Input Filter		Capacitor filter			

Output Specifications

Item	Operating Conditions	Min.	Typ.	Max.	Unit	
Voltage Accuracy	Full load, input voltage range	K7803W-500R3	--	±2	±4	%
		Others	--	±2	±3	
Linear Regulation	Full load, input voltage range	--	±0.2	±0.4		
Load Regulation	10% -100% load step; nominal input voltage	--	±0.4	±1.5		
Ripple & Noise*	20MHz bandwidth, nominal input, 10% -100% load	--	20	75	mVp-p	

Temperature Coefficient	Operating temperature -40°C to +85°C	--	--	±0.03	%/°C
Transient Response Deviation	Nominal input, 25% load step	--	50	250	mV
Transient Recovery Time		--	0.2	1	ms
Short-circuit Protection	Nominal input	Continuous, self-recovery			

Note: *1.The "parallel cable" method is used for ripple and noise test, please refer to *Non-isolated DC-DC Converter Application Notes* for specific information;
*2.With light loads at or below 10%, ripple & noise for 3.3V/5V output parts increases to 150mVp-p max, and for 9V/12V/15V output parts to 2%Vo max.

General Specifications

Item	Operating Conditions	Min.	Typ.	Max.	Unit
Operating Temperature	See Fig. 1	-40	--	+85	°C
Storage Temperature		-55	--	+125	
Pin Soldering Resistance	Soldering time: 10s (Max.)	--	--	+260	
Storage Humidity	Non-condensing	5	--	95	%RH
Switching Frequency	Full load, nominal input	550	--	850	KHz
MTBF	MIL-HDBK-217F@25°C	2000	--	--	K hours

Mechanical Specifications

Case Material	Black plastic; flame-retardant and heat-resistant (UL94 V-0)
Dimensions	11.50 x 9.00 x 17.50 mm
Weight	5.0g (Typ.)
Cooling Method	Free air convection

Electromagnetic Compatibility (EMC)

Emissions	CE	CISPR32/EN55032	CLASS B (see Fig. 5-② for recommended circuit)	
	RE	CISPR32/EN55032	CLASS B (see Fig. 5-② for recommended circuit)	
Immunity	ESD	IEC/EN 61000-4-2	Contact ±4KV	perf. Criteria B
	RS	IEC/EN 61000-4-3	10V/m	perf. Criteria A
	EFT	IEC/EN 61000-4-4	±1KV (see Fig. 5-① for recommended circuit)	perf. Criteria B
	Surge	IEC/EN 61000-4-5	line to line ±1KV (see Fig. 5-① for recommended circuit)	perf. Criteria B
	CS	IEC/EN 61000-4-6	3Vr.m.s	perf. Criteria A

Typical Characteristic Curves

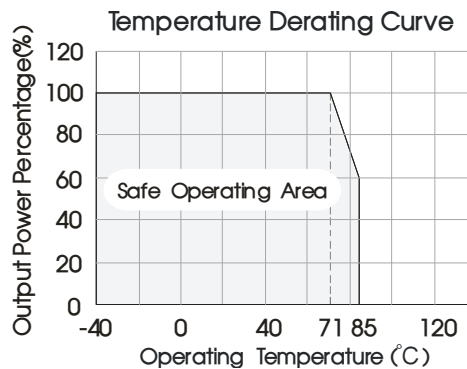
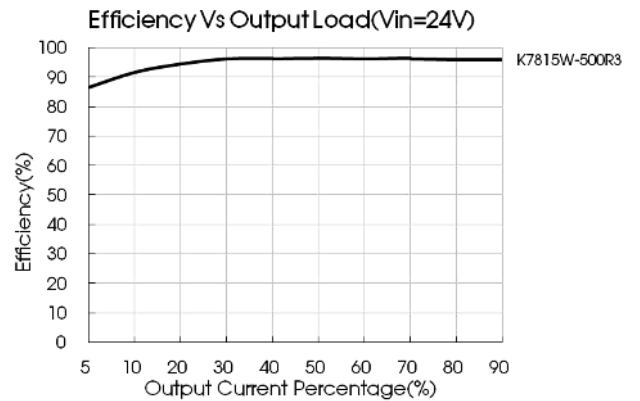
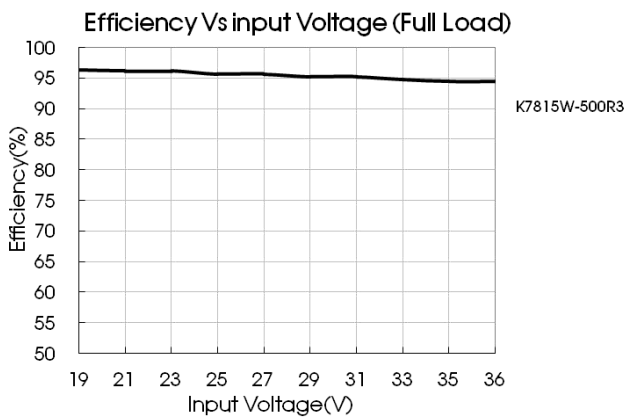
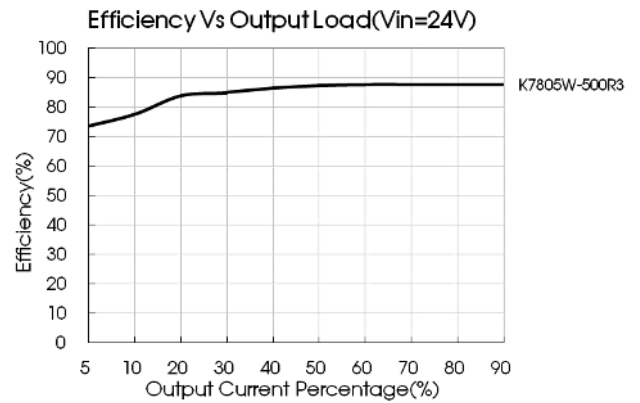
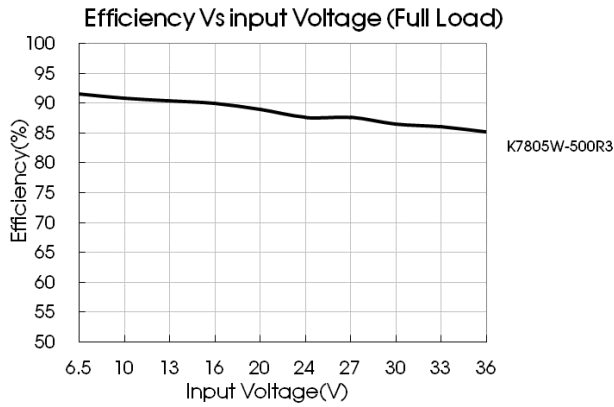

Fig. 1



Design Reference

1. Typical application

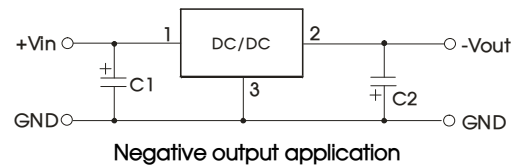
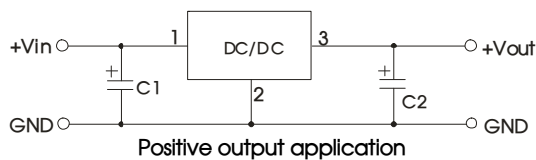

Fig. 2 Typical application

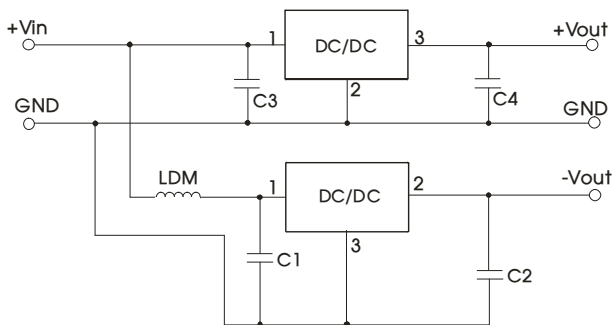
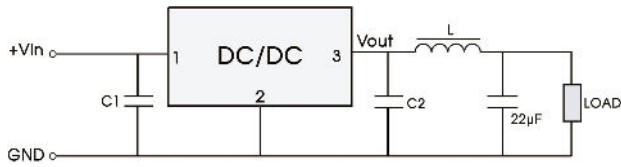

Fig. 3 Positive and Negative output in parallel application

- Note:
1. The required capacitors C1 and C2 (C3 and C4) must be connected as close as possible to the terminals of the module;
 2. Refer to Table 1 for C1 and C2 (C3 and C4) capacitor values. For certain applications, increased values and/or tantalum or low ESR electrolytic capacitor may also be used instead;
 3. When using configurations as shown in figure 3, we recommended to add an inductor (LDM) with a value of up to 10μH which helps reducing mutual interference;
 4. The products do not support parallel connection of their output and hot plug;
 5. To reduce the output ripple and noise further, it is suggested the use of a "LC" filter at the output terminals, and recommend with value of L is 10μH-47μH.

Sheet 1		
Part No.	C1/C3 (ceramic capacitor)	C2/C4 (ceramic capacitor)
K7803W-500R3	10μF/50V	22μF/10V
K7805W-500R3		22μF/10V
K7809W-500R3		22μF/16V
K7812W-500R3		22μF/25V
K7815W-500R3		22μF/25V



Positive output

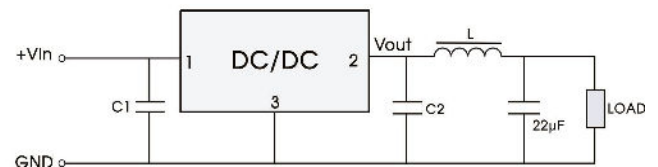

Negative output

Fig. 4 "LC" filter application

2. EMC compliance circuit

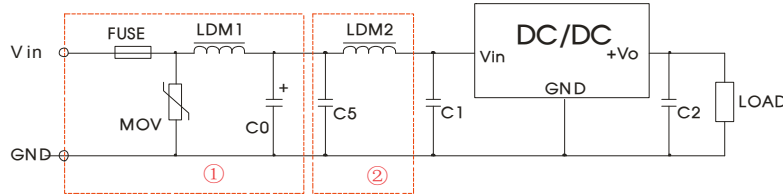

Fig. 5 EMC recommended circuit

FUSE	MOV	LDM1	C0	C1/C2	C5	LDM2
Selected based on the actual input current from the customer	S20K30	82µH	680µF /50V	Refer to Sheet 1	4.7µF /50V	12µH

Notes: For EMC tests we use Part ① in Fig. 5 for immunity and part ② for emissions test.

3. For additional information please refer to DC-DC converter application notes on www.mornsun-power.com

Dimensions and Recommended Layout

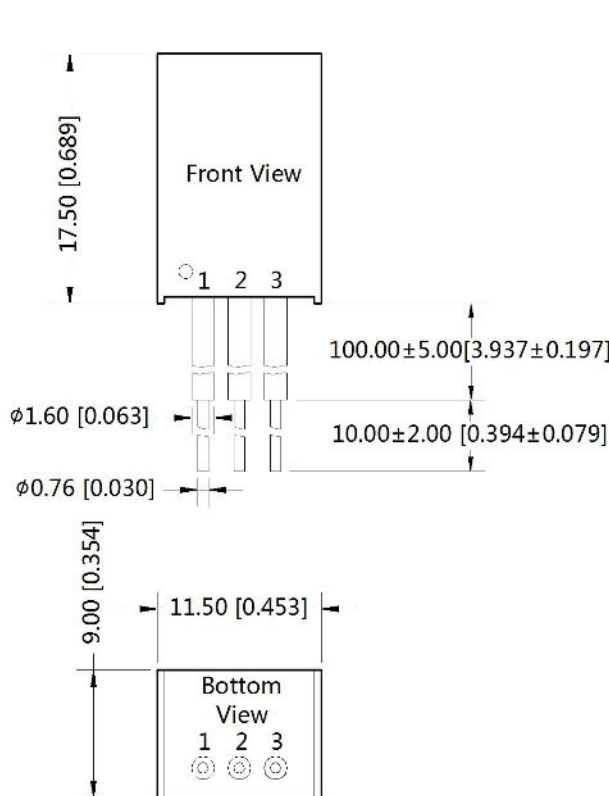

THIRD ANGLE PROJECTION

Pin-Out		
Pin	Positive Output	Negative Output
1(Red)	Vin	Vin
2(Black)	GND	-Vo
3(Yellow)	+Vo	GND

Note:
Unit: mm[inch]
Wire type: UL1569 AWG22 (300V 105°C)
General tolerances: ±0.50[±0.020]

Notes:

1. For additional information on Product Packaging please refer to www.mornsun-power.com. Packaging bag number: 58010119;
2. The specified maximum capacitive load is tested under full load condition and over the input voltage range;
3. Unless otherwise specified, parameters in this datasheet were measured under the conditions of $T_a=25^{\circ}\text{C}$, humidity<75%RH with nominal input voltage and rated output load;
4. All index testing methods in this datasheet are based on our company corporate standards;
5. We can provide product customization service, please contact our technicians directly for specific information;
6. Products are related to laws and regulations: see "Features" and "EMC";
7. Our products shall be classified according to ISO14001 and related environmental laws and regulations, and shall be handled by qualified units.

MORNSUN Guangzhou Science & Technology Co., Ltd.

Address: No. 5, Kehui St. 1, Kehui Development Center, Science Ave., Guangzhou Science City, Huangpu District, Guangzhou, P. R. China

Tel: 86-20-38601850

Fax: 86-20-38601272

E-mail: info@mornsun.cn

www.mornsun-power.com