

### Typical Features

- ◆ Fixed input voltage, Isolated & unregulated output, Output power 1W
- ◆ High Efficiency up to 86%
- ◆ Small compact SIP packing
- ◆ Isolation Voltage 1500VDC
- ◆ Operating Temperature: -40°C ~ +105°C
- ◆ Plastic Case, meet UL94 V-0 standard



**Test Condition:** Unless otherwise specified, data in the datasheet should be tested under the conditions of inputting nominal voltage, pure resistance rated load and Ta=25°C

### Application Field

*It could be widely used for instrument, communication, pure digital circuit, general low frequency analog circuit, relay drive circuit, data exchange circuit, etc.*

### Typical Product List

Model	Input Voltage Range (VDC)		Output Voltage/Current (Vo/Io)		Input Current(mA) Nominal Voltage		Max. Capacitive Load uF	Ripple & Noise (Max.) mVp-p	Efficiency (%)@ output full load, nominal input voltage	
	Nominal	Range	Voltage (VDC)	Current(mA) MAX./Min.	Full load Typ.	No Load Typ.			Min.	Typ.
FN1-3V3S3V3BN	3.3	2.97	3.3	303/30	370	8	2400	100	73	76
FN1-3V3S05BN		- 3.63	5	200/20	358	8	2400	100	80	83
FN1-05S3V3BN	5	4.5 - 5.5	3.3	303/30	250	8	2400	100	77	80
FN1-05S05BN			5	200/20	225	8	2400	100	82	85
FN1-05S09BN			9	111/12	227	10	1000	100	82	85
FN1-05S12BN			12	83/9	220	10	560	100	82	85
FN1-05S15BN			15	67/7	220	18	560	100	82	85
FN1-05S24BN			24	42/5	266	18	220	100	81	84
FN1-09S09BN			9	8.1-9.9	9	111/12	128	10	1000	100
FN1-12S3V3BN	12	10.8 - 13.2	3.3	303/30	98	10	2400	100	79	82
FN1-12S05BN			5	200/20	96	10	2400	100	83	86
FN1-12S09BN			9	111/12	92	10	1000	100	83	86
FN1-12S12BN			12	83/9	90	10	560	100	83	86
FN1-12S15BN			15	67/7	90	10	560	100	83	86
FN1-12S24BN			24	42/5	92	10	220	100	82	85
FN1-15S05BN	15	13.5	5	200/20	78	10	2400	100	82	85

FN1-15S12BN	-	16.5	12	83/9	76	10	1000	100	83	86
FN1-15S15BN			15	67/7	76	10	560	100	82	85
FN1-15S24BN			24	42/5	84	10	560	100	80	83
FN1-24S3V3BN	24	21.6 - 26.4	3.3	303/30	48	8	2400	100	79	82
FN1-24S05BN			5	200/20	47	8	2400	100	81	84
FN1-24S09BN			9	111/12	48	8	1000	100	83	85
FN1-24S12BN			12	83/9	48	8	560	100	83	86
FN1-24S15BN			15	67/7	48	8	560	100	82	85
FN1-24S24BN			24	42/5	49	8	220	100	82	85
FN1-05D3V3BN	5	4.5 - 5.5	±3.3	±152/±16	260	10	1200	100	76	79
FN1-05D05BN			±5	±100/±10	240	10	1200	100	80	83
FN1-05D09BN			±9	±56/±6	238	10	560	100	80	83
FN1-05D12BN			±12	±42/±5	238	10	560	100	80	83
FN1-05D15BN			±15	±33/±4	234	18	220	100	80	83
FN1-05D24BN			±24	±21/±3	250	18	220	100	79	82
FN1-09D09BN	9	8.1 - 9.9	±9	±56/±6	135	12	560	100	79	82
FN1-12D05BN	12	10.8 - 13.2	±5	±100/±10	100	10	1200	100	81	84
FN1-12D09BN			±9	±56/±6	100	10	560	100	81	84
FN1-12D12BN			±12	±42/±5	100	10	560	100	81	84
FN1-12D15BN			±15	±33/±4	103	10	220	100	81	84
FN1-12D24BN			±24	±21/±3	100	10	220	100	81	84
FN1-15D05BN	15	13.5 - 16.5	±5	±100/±10	86	10	1200	100	78	81
FN1-15D12BN			±12	±42/±5	86	10	560	100	78	81
FN1-15D15BN			±15	±33/±4	86	10	220	100	81	83
FN1-24D05BN	24	21.6 - 26.4	±5	±100/±10	50	8	1200	100	79	82
FN1-24D09BN			±9	±56/±6	50	8	560	100	80	83
FN1-24D12BN			±12	±42/±5	50	8	220	100	81	84
FN1-24D15BN			±15	±33/±4	50	8	220	100	80	83

**Note:**

1. In order to ensure the converter can work reliably with high efficiency, the minimum load should not less than 10% rated load when it is used. If the needed power is indeed small, please parallel a resistor at the output side, the resistance recommended equal to 10% nominal power.

2. The capacitive loads of positive and negative outputs are identical.

**Input Specifications**

Item	Test Condition	Min.	Typ.	Max.	Unit
Input Overshoot Voltage (1Second.max.)	3.3Vdc Input	-0.7	-	7	VDC
	5Vdc Input	-0.7	-	9	
	9Vdc Input	-0.7	-	12	
	12Vdc Input	-0.7	-	18	
	15Vdc Input	-0.7	-	21	
	24Vdc Input	-0.7	-	30	
Input Filter	Capacitor Filter				

**Output Specifications**

ITEM	Working Conditions	Min.	Typ.	Max.	Unit
Output Power		0.1	--	1	W
Output Voltage Accuracy	Nominal input, Full load	--	±2	±5	%
Load Regulation	10% ~ 100% nominal load	3.3Vdc output	--	20	
		Other output	--	15	
Line Voltage Regulation	Input Voltage Change±1%	3.3Vdc output	--	±1.5	
		Other output	--	±1.2	
Ripple & Noise①	Nominal input,full load, 20MHZ bandwidth	Other output	--	75	mVp-p
		24Vdc output	--	90	
Temperature Drift Coefficient	100% Full Load	--	--	±0.03	%/°C
Output Short Circuit Protection②	Continuous short-circuit protection, self-recovery				

NOTE:①Ripple & Noise tested by twisted-pair method,

**General Specifications**

Switching Frequency	typical	260KHz (Typ.)
Operating Temperature	Refer to Temperature Derating Curve	-40°C ~ +105°C
Storage Temperature		-55°C ~ +125°C
Shell temperature rise during work	Within Temperature Derating Curve	25°C(Typ.)
Relative Humidity	No condensing	5%~95%
Case Material		Black flame-retardant heat-resistant Plastic(UL94 V-0)
Pin Withstand Soldering Temp	Distance to Case 1.5mm, 10S	300°C MAX
Isolation Voltage	Test 1 minute, leakage current< 0.5mA	1500Vdc
Isolation Capacitor	Input/Output,100KHz/0.1V	20 pF (Typ.)

MTBF	MIL-HDBK-217F@25°C	35X10 <sup>5</sup> Hrs
Product Weight		2.1g(Typ.)
Packing	Tube(525*18*10mm)	25PCS
	Box(542*110*155mm)	2000PCS(Total 80Tubes)

**EMC Characteristics**

EMI	CS	CISPR32/EN55032 CLASS B (see recommended EMC circuit)
	RS	CISPR32/EN55032 CLASS B (see recommended EMC circuit)
EMS	ESD	IEC/EN61000-4-2 Air±8kV,Contact±6kV perf.Criteria B

**Packing Dimension**

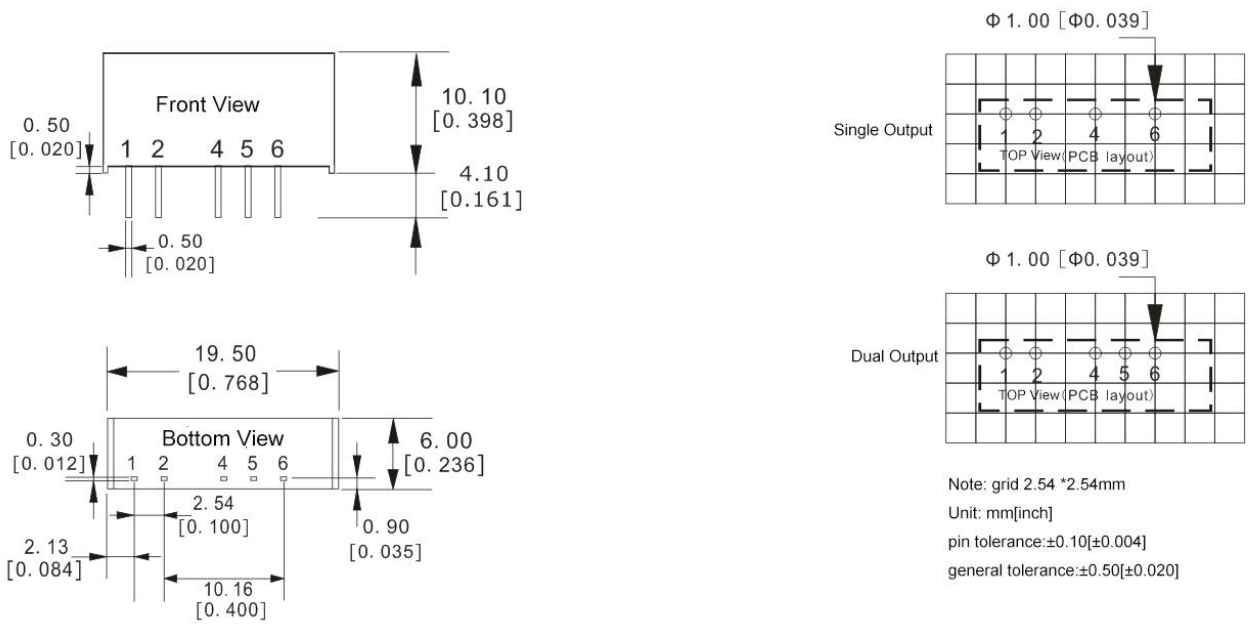

**Dimension Size**

**Recommended PCB Printing**

Packing Code	L x W x H	
B	19.50× 6.00 × 10.00mm	0.768 × 0.236 × 0.394inch

**Pin Function**

Pin Function	1	2	3	4	5	6
Single(S)	+Vin	GND	--	-Vo	--	+Vo
Dual(D)	+Vin	GND	--	-Vo	COM	+Vo

Note: if the definition of pin is not in accordance with the model selection manual, please refer to the label on actual item.

**Ripple & Noise Test: (Twisted Pair Method 20MHZ bandwidth)**

**Test Method:**

a. 12# twisted pair to connect, Oscilloscope bandwidth set as 20MHz, 100M bandwidth probe, terminated with 0.1uF polypropylene capacitor and 10uF high frequency low resistance electrolytic capacitor in parallel, oscilloscope set as Sample pattern.

b. Input terminal connect to power supply, output terminal connect to electronic load through jig plate, Use 30cm±2 cm sampling line, Power line selected from corresponding diameter wire with insulation according to the flow of output current.

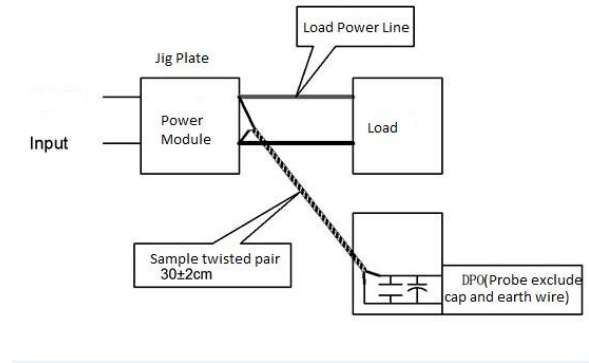

**Temperature Curve**

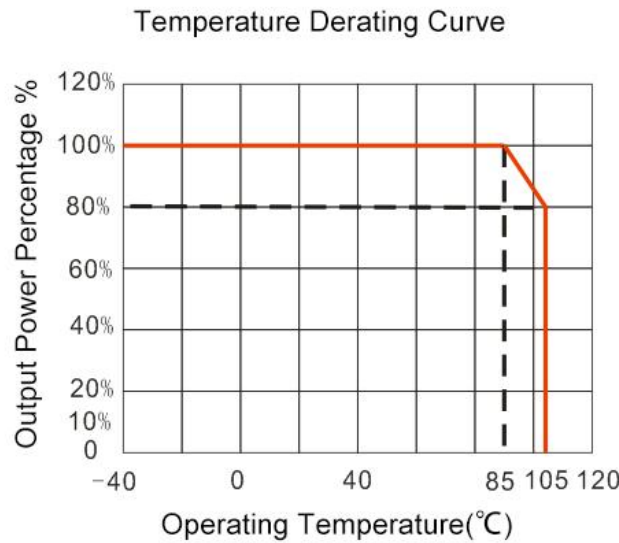

**Design and Application Circuit Recommended**

**1. Output load requirements**

a. In order to ensure the converter can work reliably with high efficiency, the minimum load should not less than 10% rated load when it is used. If the needed power is indeed small, please parallel a resistor at the output side, the resistance equal to 10% nominal load.

b. The maximum capacitive load is tested under nominal input full load, and cannot exceed the maximum capacitive load of output terminal under operation, otherwise it will cause it difficult to start up and damage the product.

**2. Recommended circuit**

In order to ensure the input/output ripple and noise decreased, capacitor filter net could be connected to input and output terminal, application circuit as below photo 1; choosing suitable filter capacitor is very important, start-up problems may be caused by too large capacitance. To ensure the modules running safely and reliably, the recommended capacitive load values as shown in Table 1. (But for the actual output power of application circuit is less than 0.5W, suggest not to connect external capacitor)

**Single**

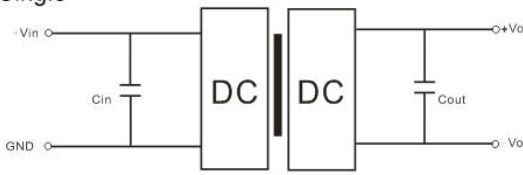

Recommended capacitive load value table (Table 1)

Vin (Vdc)	Cin	Single(Vout) Vdc	Cout (μF)	Dual Vout (Vdc)	Cout (μF)
5	10 μF/16V	3.3	10 μF/16V	±3.3	4.7 μF/16V
12	2.2 μF/25V	5	10 μF/16V	±5	4.7 μF/16V
15	2.2 μF/25V	9	2.2 μF/25V	±9	2.2 μF/25V
24	1 μF/50V	12	2.2 μF/25V	±12	1 μF/25V
--	--	15	1 μF/25V	±15	1 μF/16V
--	--	24	1 μF/50V	±24	0.47 μF/50V

**Dual**

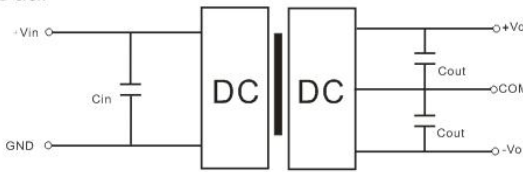

**3. EMC typical recommended circuit**

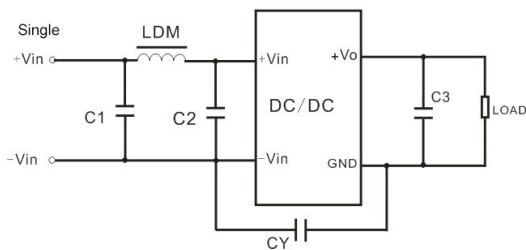

Input Voltage		3.3/5/9VDC	12/15/24VDC
EMI	C1/C2	4.7 μF/16V	4.7 μF/50V
	CY	270pF/2kV	270pF/2kV
	C3	Recommend Cout spec at Table 1	
	LDM	6.8 μH	6.8 μH

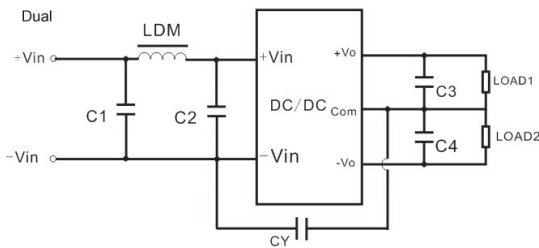

Input Voltage		3.3/5/9VDC	12/15/24VDC
EMI	C1/C2	4.7 μF/16V	4.7 μF/50V
	CY	270pF/2kVdc	270pF/2kVdc
	C3/C4	Recommend Cout spec at Table 1	
	LDM	6.8 μH	6.8 μH

**4. Output regulated voltage and over voltage protection circuit**

The simplest device to protect output regulated voltage, over voltage and over current is to cascade a linear regulator with overheat protection at input or output terminal, and connect a capacitor filter net(see below picture), filter capacitive value recommended see table 1, Linear regulator is chosen according to the actual voltage, current needed in working, or choose our NW series products.

**Single**



**Positive Negative Dual Output**

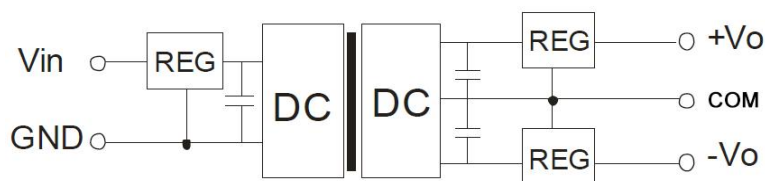

**Guangzhou Aipu Electron Technology Co., Ltd**

Address: Building 4, HEDY Park, No.63, Punan Road, Huangpu Dist, Guangzhou, China.

Tel: 86-20-84206763 Fax: 86-20-84206762 HOTLINE: 400-889-8821

E-mail: sales@aipu-elec.com Website: www.aipupower.com