

# MTW Series, 360 Watt

## DC/DC Converters



The 4:1 Input Voltage 360 Watt Single MTW DC/DC converter provides a precisely regulated dc output. The output voltage is fully isolated from the input, allowing the output to be positive or negative polarity and with various ground connections. The 360 Watt MTW meets the most rigorous performance standards in an industry standard footprint for mobile (12VIN), process control (24VIN), and military COTS (28VIN) applications.

The 4:1 Input Voltage 360 Watt MTW includes trim and remote ON/OFF. Threaded through holes are provided to allow easy mounting or addition of a heatsink for extended temperature operation.

The converters high efficiency and high power density are accomplished through use of high-efficiency synchronous rectification technology, advanced electronic circuit, packaging and thermal design thus resulting in a high reliability product. Converter operates at a fixed frequency and follows conservative component de-rating guidelines.

Product is designed and manufactured in the USA.

### Features

- 4:1 Input voltage range
- High power density
- Small size 2.4" x 2.5" x 0.52"
- Efficiency up to 95.6%
- Excellent thermal performance with metal case
- Over-Current and Short Circuit Protection
- Over-Temperature protection
- Auto-restart
- Monotonic startup into pre-bias
- Constant frequency
- Remote ON/OFF
- Good shock and vibration damping
- Temperature Range -40°C to +105°C Available
- RoHS Compliant
- UL60950 Approved

### Table of Contents

Part Number Selection Table & Description . . . . .	2
Electrical Specifications . . . . .	3
Environmental and Mechanical Specifications . . . . .	7
Operations . . . . .	8

Protection Features . . . . .	9
Characteristic Curves . . . . .	12
Characteristic Waveforms . . . . .	14
EMC Consideration . . . . .	17
Mechanical Specification . . . . .	18



# MTW Series, 360 Watt

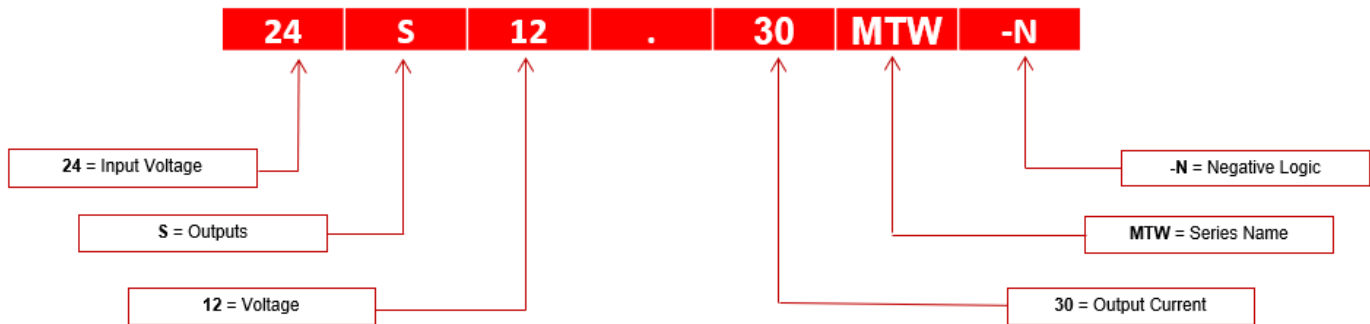
DC/DC Converters

## Part Number Selection Table

Voltage (VDC)		Current				Efficiency	Ripple & Noise	Regulation	Capacitive Load	Root Model
Input	Output	Input		Output						
Vin Nom	Vin Range	Vout Nom	No Load (mA)	Max Load (A)	Io Max (A)	Typical at Max Load (%)	Typical (mVp-p)	Line / Load Max (%)	Max. C external (µF)	Basic Model without option
24	9 – 36	12	.24	45	30	94.4	120	.05/.08	4700	24S12.30MTW
		24	.24	45	15	95.2	240	.05/.08	2200	24S24.15MTW
		28	.24	50	13	95.4	280	.05/.08	2200	24S28.13MTW

1. Negative Logic On/Off feature is available. Add "-N" to the part number when ordering. i.e. 24S12.30MTW-N (ROHS)
2. Designed to meet MIL-STD-810G for functional shock and vibration. The unit must be properly secured to the interface medium (PCB/Chassis) by use of the threaded inserts of the unit.
3. A thermal management device, such as a heatsink, is required to ensure proper operation of this device. The thermal management medium is required to maintain baseplate < 105°C for full rated power.
4. Non-standard output voltages are available. Please contact the factory for additional information.

## Part Number Description





# MTW Series, 360 Watt

DC/DC Converters

## Electrical Specifications

Conditions:  $T_A = 25^\circ\text{C}$ , airflow = 300 LFM (1.5m/s),  $V_{IN} = 24\text{VDC}$ , unless otherwise specified. Specifications subject to change without notice.

<b>All Models</b>					
Parameter	Notes	Min	Typ	Max	Units
<b>Absolute Maximum Ratings</b>					
Input Voltage	Continuous	0		40	V
	Transient (100ms)			50	V
Operating Temperature	Baseplate (100% load)	-40		105	$^\circ\text{C}$
Storage Temperature		-55		125	$^\circ\text{C}$
<b>Isolation Characteristics and Safety</b>					
Isolation Voltage	Input to Output	2250			V
	Input to Baseplate & Output to Baseplate	1500			V
Isolation Capacitance			4500		pF
Isolation Resistance		10	20		$\text{M}\Omega$
Insulation Safety Rating			Basic		
Designed to meet UL/cUL 60950, IEC/EN 60950-1					
<b>Feature Characteristics</b>					
Fixed Switching Frequency	Output Voltage Ripple has twice this frequency		200		kHz
Output Voltage Trim Range				$\pm 10$	%
Remote Sense Compensation	This function is not provided		N/A		%
Output Overvoltage Protection	Non-latching	117	124	130	%
Over Temperature Shutdown (Baseplate)	Non-latching		110	120	$^\circ\text{C}$
Auto-Restart Period	Applies to all protection features	450	500	550	ms
Turn-On Time from VIN	Time from UVLO to $V_o=90\%$ VOUT (NOM) Resistive load		517	530	ms
Turn-On time from ON/OFF Control	Trim from ON to $V_o=90\%$ VOUT (NOM) Resistive load		17	20	ms
Rise Time	VOUT from 10% to 90%	4	7.5	11	ms
<b>ON/OFF Control – Positive Logic</b>					
On State	Pin open = ON or external voltage applied	2		12	V
Current Control	Leakage current			0.16	mA
OFF State		0		0.8	V
Control Current	Sinking	0.3		0.36	mA
<b>ON/OFF Control – Negative Logic</b>					
ON State	Pin shorted to -INPUT or			0.8	V
OFF State	Pin open = OFF or	2		12	V
<b>Thermal Characteristics</b>					
Thermal resistance Baseplate to Ambient	Converter soldered to 3.95" x 2.5" x 0.07" 4 layer / 2oz copper FR4 PCB		5.2		$^\circ\text{C}/\text{W}$



# MTW Series, 360 Watt

DC/DC Converters

## Electrical Specifications (Continued):

Conditions:  $T_A = 25^\circ\text{C}$ , airflow = 300 LFM (1.5m/s),  $V_{IN} = 24\text{VDC}$ , unless otherwise specified. Specifications subject to change without notice.

<b>24S12.30MTW</b>						
Parameter	Notes	Min	Typ	Max	Units	
<b>Input Characteristics</b>						
Operating Input Voltage Range		9	24	36	V	
<b>Input Under Voltage Lockout</b>	Non-latching					
Turn-on Threshold		8.2	8.5	8.8	V	
Turn-off Threshold		7.7	8	8.3	V	
Lockout Hysteresis Voltage		0.4	0.55	0.7	V	
Maximum Input Current	$V_{IN} = 9\text{V}$ , 80% Load			45.3	A	
	$V_{IN} = 12\text{V}$ , 100% Load			33.2	A	
	$V_{IN} = 24\text{V}$ , Output Shorted		65		$\text{mA}_{\text{RMS}}$	
Input Stand-by Current	Converter Disabled		2	4	mA	
Input Current @ No Load	Converter Enabled		240	280	mA	
Minimum Input Capacitance (external)	ESR < 0.1 $\Omega$	470			$\mu\text{F}$	
Inrush Transient	$V_{IN} = 36\text{V}$ (0.4V/ $\mu\text{s}$ ) no external input cap		0.4	1	$\text{A}^2\text{s}$	
Input Terminal Ripple Current, $i_c$	25 MHz bandwidth, 100% Load (Fig. 2)		560		$\text{mA}_{\text{RMS}}$	
<b>Output Characteristics</b>						
Output Voltage Range		11.64	12.00	12.36	V	
Output Voltage Set Point Accuracy	(50% Load)	11.88	12.00	12.12	V	
<b>Output Regulation</b>						
Over Line	$V_{IN} = 9\text{V}$ to 36V		0.05	0.15	%	
Over Load	$V_{IN} = 24\text{V}$ , Load 0% to 100%		0.08	0.15	%	
Temperature Coefficient			0.015	0.03	%/ $^\circ\text{C}$	
Over Voltage Protection		14.0		15.6	V	
Output Ripple and Noise – 20 MHz bandwidth	(Fig. 3) 100% Load $C_{\text{EXT}} = 470 \mu\text{F}/70\text{m}\Omega + 1 \mu\text{F}$ ceramic		120	180	$\text{mV}_{\text{PK-PK}}$	
			30	60	$\text{mV}_{\text{RMS}}$	
External Load Capacitance	Full Load (resistive) -40 $^\circ\text{C}$ < $T_a$ < +105 $^\circ\text{C}$	$C_{\text{EXT}}$	470	4700	$\mu\text{F}$	
		ESR	10	100	$\text{m}\Omega$	
Output Current Range (See Fig. A)	$V_{IN} = 9\text{V}$ to 36V	0		30	A	
Current Limit Inception	$V_{IN} = 9\text{V} - 36\text{V}$	33	36	39	A	
RMS Short-Circuit Current	Non-latching, Continuous		4	7	$\text{A}_{\text{RMS}}$	
<b>Dynamic Response</b>						
Load change 50% - 75% - 50%, di/dt = 1A/ $\mu\text{s}$	$C_o = 470 \mu\text{F}/70\text{m}\Omega + 1 \mu\text{F}$ ceramic		$\pm 200$	$\pm 320$	mV	
Load change 50% - 100% - 50%, di/dt = 1A/ $\mu\text{s}$	$C_o = 470 \mu\text{F}/70\text{m}\Omega + 1 \mu\text{F}$ ceramic		$\pm 450$		mV	
Setting Time to 1% of $V_{\text{OUT}}$			400		$\mu\text{s}$	
<b>Efficiency</b>						
100% Load	$V_{IN} = 24\text{V}$	93.7	94.4	95.1	%	
	$V_{IN} = 12\text{V}$	92.9	93.6	94.3	%	
50% Load	$V_{IN} = 24\text{V}$	94.1	94.8	95.5	%	
	$V_{IN} = 12\text{V}$	94	94.7	95.1	%	



# MTW Series, 360 Watt

DC/DC Converters

## Electrical Specifications (Continued):

Conditions:  $T_A = 25^\circ\text{C}$ , airflow = 300 LFM (1.5m/s),  $V_{IN} = 24\text{VDC}$ , unless otherwise specified. Specifications subject to change without notice.

<b>24S24.15MTW</b>						
Parameter	Notes	Min	Typ	Max	Units	
<b>Input Characteristics</b>						
Operating Input Voltage Range		9	24	36	V	
<b>Input Under Voltage Lockout</b>	Non-latching					
Turn-on Threshold		8.2	8.5	8.8	V	
Turn-off Threshold		7.7	8	8.3	V	
Lockout Hysteresis Voltage		0.4	0.55	0.7	V	
Maximum Input Current	$V_{IN} = 9\text{V}$ , 80% Load			45	A	
	$V_{IN} = 12\text{V}$ , 100% Load			42	A	
	$V_{IN} = 24\text{V}$ , Output Shorted		75		$\text{mA}_{\text{RMS}}$	
Input Stand-by Current	Converter Disabled		2	4	mA	
Input Current @ No Load	Converter Enabled		240	300	mA	
Minimum Input Capacitance (external)	ESR < 0.1 $\Omega$	470			$\mu\text{F}$	
Inrush Transient	$V_{IN} = 36\text{V}$ (0.4V/ $\mu\text{s}$ ) no external input cap		0.4	1	$\text{A}^2\text{s}$	
Input Terminal Ripple Current, $i_c$	25 MHz bandwidth, 100% Load (Fig. 2)		600		$\text{mA}_{\text{RMS}}$	
<b>Output Characteristics</b>						
Output Voltage Range		23.28	24.00	24.72	V	
Output Voltage Set Point Accuracy	(50% Load)	23.76	24.00	24.24	V	
<b>Output Regulation</b>						
Over Line	$V_{IN} = 9\text{V}$ to 36V		0.05	0.15	%	
Over Load	$V_{IN} = 24\text{V}$ , Load 0% to 100%		0.08	0.15	%	
Temperature Coefficient			0.015	0.03	%/ $^\circ\text{C}$	
Over Voltage Protection		28.1		31.2	V	
Output Ripple and Noise – 20 MHz bandwidth	(Fig. 3) 100% Load $C_{\text{EXT}} = 470 \mu\text{F}/70\text{m}\Omega + 1 \mu\text{F}$ ceramic		240	360	$\text{mV}_{\text{PK-PK}}$	
			50	80	$\text{mV}_{\text{RMS}}$	
External Load Capacitance	Full Load (resistive) -40 $^\circ\text{C} < T_a < +105 \text{ }^\circ\text{C}$	$C_{\text{EXT}}$	470		2200	$\mu\text{F}$
		ESR	10		100	$\text{m}\Omega$
Output Current Range (See Fig. A)	$V_{IN} = 9\text{V}$ to 36V	0		15	A	
Current Limit Inception	$V_{IN} = 9\text{V} - 36\text{V}$	16.5	18	19.5	A	
RMS Short-Circuit Current	Non-latching, Continuous		3.8	6	$\text{A}_{\text{RMS}}$	
<b>Dynamic Response</b>						
Load change 50% - 75% - 50%, $di/dt = 1\text{A}/\mu\text{s}$	$C_o = 470 \mu\text{F}/70\text{m}\Omega + 1 \mu\text{F}$ ceramic		$\pm 280$	$\pm 420$	mV	
Load change 50% - 100% - 50%, $di/dt = 1\text{A}/\mu\text{s}$	$C_o = 470 \mu\text{F}/70\text{m}\Omega + 1 \mu\text{F}$ ceramic		$\pm 500$		mV	
Setting Time to 1% of $V_{\text{OUT}}$			600		$\mu\text{s}$	
<b>Efficiency</b>						
100% Load	$V_{IN} = 24\text{V}$	94.5	95.2	95.9	%	
	$V_{IN} = 12\text{V}$	93.8	94.5	95.2	%	
50% Load	$V_{IN} = 24\text{V}$	94.5	95.4	96.1	%	
	$V_{IN} = 12\text{V}$	94.6	95.2	95.9	%	



# MTW Series, 360 Watt

DC/DC Converters

## Electrical Specifications (Continued):

Conditions:  $T_A = 25\text{ }^\circ\text{C}$ , Airflow = 300 LFM (1.5 m/s),  $V_{in} = 24\text{VDC}$ , unless otherwise specified. Specifications are subject to change without notice.

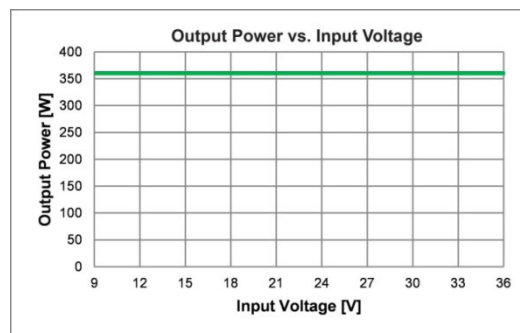
<b>24S28.36FXW</b>						
Parameter	Notes	Min	Typ	Max	Units	
<b>Input Characteristics</b>						
Operating Input Voltage Range		9	24	36	V	
<b>Input Under Voltage Lockout</b>	Non-latching					
Turn-on Threshold		8.2	8.5	8.8	V	
Turn-off Threshold		7.7	8	8.3	V	
Lockout Hysteresis Voltage		0.4	0.55	0.7	V	
Maximum Input Current	$V_{IN} = 9\text{V}$ , 80% Load			45	A	
	$V_{IN} = 12\text{V}$ , 100% Load			42	A	
	$V_{IN} = 24\text{V}$ , Output Shorted		55		$\text{mA}_{\text{RMS}}$	
Input Stand-by Current	Converter Disabled		2	4	mA	
Input Current @ No Load	Converter Enabled		240	280	mA	
Minimum Input Capacitance (external)	ESR < 0.1 $\Omega$	470			$\mu\text{F}$	
Inrush Transient	$V_{IN} = 36\text{V}$ (0.4V/ $\mu\text{s}$ ) no external input cap		0.4	1	$\text{A}^2\text{s}$	
Input Terminal Ripple Current, $i_c$	25 MHz bandwidth, 100% Load (Fig. 2)		560		$\text{mA}_{\text{RMS}}$	
<b>Output Characteristics</b>						
Output Voltage Range		27.16	28.00	28.84	V	
Output Voltage Set Point Accuracy	(50% Load)	27.72	28.00	28.28	V	
<b>Output Regulation</b>						
Over Line	$V_{IN} = 9\text{V}$ to 36V		0.05	0.15	%	
Over Load	$V_{IN} = 24\text{V}$ , Load 0% to 100%		0.08	0.15	%	
Temperature Coefficient			0.015	0.03	%/ $^\circ\text{C}$	
Over Voltage Protection		32.8		36.4	V	
Output Ripple and Noise – 20 MHz bandwidth	(Fig. 3) 100% Load		280	380	$\text{mV}_{\text{PK-PK}}$	
	$C_{\text{EXT}} = 470\text{ }\mu\text{F}/70\text{m}\Omega + 1\text{ }\mu\text{F}$ ceramic		50	85	$\text{mV}_{\text{RMS}}$	
External Load Capacitance	Full Load (resistive) -40 $^\circ\text{C}$ < $T_a$ < +105 $^\circ\text{C}$	$C_{\text{EXT}}$	470		2200	$\mu\text{F}$
		ESR	10		100	$\text{m}\Omega$
Output Current Range (See Fig. A)	$V_{IN} = 9\text{V}$ to 36V	0		13	A	
Current Limit Inception	$V_{IN} = 9\text{V}$ - 36V	14.3	15.6	16.9	A	
RMS Short-Circuit Current	Non-latching, Continuous		2.2	6	$\text{A}_{\text{RMS}}$	
<b>Dynamic Response</b>						
Load change 50% - 75% - 50%, $di/dt = 1\text{A}/\mu\text{s}$	$C_o = 470\text{ }\mu\text{F}/70\text{m}\Omega + 1\text{ }\mu\text{F}$ ceramic		$\pm 180$	$\pm 300$	mV	
Load change 50% - 100% - 50%, $di/dt = 1\text{A}/\mu\text{s}$	$C_o = 470\text{ }\mu\text{F}/70\text{m}\Omega + 1\text{ }\mu\text{F}$ ceramic		$\pm 400$		mV	
Setting Time to 1% of $V_{\text{OUT}}$			500		$\mu\text{s}$	
<b>Efficiency</b>						
100% Load	$V_{IN} = 24\text{V}$	94.3	95.4	96.1	%	
	$V_{IN} = 12\text{V}$	93.7	94.4	95.1	%	
50% Load	$V_{IN} = 24\text{V}$	94.3	95.0	95.7	%	
	$V_{IN} = 12\text{V}$	94.0	94.7	95.1	%	

### Environmental and Mechanical Specifications. Specifications subject to change without notice.

Parameter	Note	Min	Typ	Max	Units
<b>Environmental</b>					
Operating Humidity	Non-condensing			95	%
Storage Humidity	Non-condensing			95	%
ROHS Compliance <sup>1</sup>	See Calex Website <a href="http://www.calex.com/RoHS.html">http://www.calex.com/RoHS.html</a> for the complete RoHS Compliance Statement				
<b>Shock and Vibration</b>	Designed to meet MIL-STD-810G for functional shock and vibration				
<b>Water Washability</b>	Not recommended for water wash process. Contact the factory for more information.				
<b>Mechanical</b>					
Weight		3.85			Ounces
		109.2			Grams
<b>PCB</b>					
Operating Temperature				130	°C
T <sub>g</sub>		170			°C
Through Hole Pin Diameters	Pins 1, 4, 5 and 9	0.079	0.081	0.083	Inches
		2.006	2.057	2.108	mm
	Pins 3 and 7	0.038	0.04	0.042	Inches
		0.965	1.016	1.067	mm
Through Hole Pin Material	Pins 1, 4, 5 and 9	C14500 or C1100 Copper Alloy			
	Pins 3 and 7	Brass Alloy TB3 or "Eco Brass"			
Through Hole Pin Finish	All pins	10μ" Gold over Nickel			
Case Dimensions		2.4 x 2.5 x 0.52			Inches
		60.96 x 63.50 x 13.21			mm
Case Material	Plastic: Vectra LCP FIT30: ½ - 16 EDM Finish				
Baseplate	Material	Aluminum			
	Flatness		0.008		Inches
			0.20		mm
<b>Reliability</b>					
MTBF	Telcordia SR-332, Method 1 Case 1 50% electrical stress, 40 °C components		5.4		MHrs
<b>Agency Approvals</b>	UL60950				
<b>EMI and Regulatory Compliance</b>					
Conducted Emissions	MIL-STD-461F CE102 with external EMI filter network (see Figs, 28 and 29)				

Additional Notes:

1 The RoHS marking is as follows



**Figure A:** Output Power as function of input voltage.

### Operations

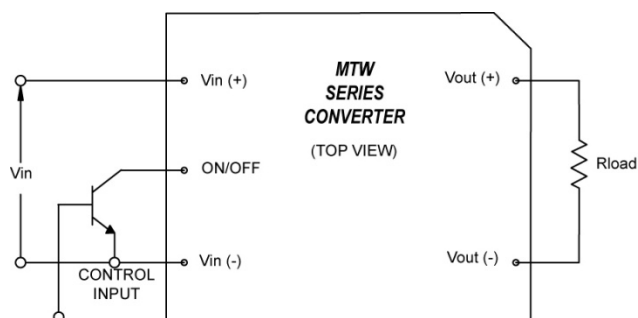
#### Input and Output Capacitance

In many applications, the inductance associated with the distribution from the power source to the input of the converter can affect the stability of the converter. This becomes of great consideration for input voltage at 12V or below. In order to enable proper operation of the converter, in particular during load transients, an additional input capacitor is required. Minimum required input capacitance, mounted close to the input pins, is 1000 $\mu$ F with ESR < 0.1  $\Omega$ . Since inductance of the input power cables could have significant voltage drop due to rate of change of input current  $di(in)/dt$  during transient load operation an external capacitance on the output of the converter is required to reduce  $di(in)/dt$ . It is required to use at least 470  $\mu$ F (ESR < 0.07 $\Omega$ ) on the output. Another constraint is minimum rms current rating of the input and output capacitors which is application dependent. One component of input rms current handled by input capacitor is high frequency component at switching frequency of the converter (typ. 400kHz) and is specified under "Input terminal ripple current"  $i_c$ . Typical values at full rated load and 24  $V_{in}$  are provided in Section "Characteristic Waveforms" for each model and are in range of 0.56A - 0.6A. Second component of the ripple current is due to reflected step load current on the input of the converter. Similar consideration needs to be taken into account for output capacitor and in particular step load ripple current component. Consult the factory for further application guidelines.

Additionally, for EMI conducted measurement it is necessary to use 5 $\mu$ H LISNs instead of typical 50 $\mu$ H LISNs.

#### ON/OFF (Pin 3)

The ON/OFF pin is used to turn the power converter on or off remotely via a system signal and has positive logic. A typical connection for remote ON/OFF function is shown in Fig. 1.



The positive logic version turns on when the ON/OFF pin is at logic high and turns off when at logic low. The converter is on when the ON/OFF pin is either left open or external voltage not more than 12V is applied between ON/OFF pin and -INPUT pin. See the Electrical Specifications for logic high/low definitions.

The negative logic version turns on when the ON/OFF pin is at logic low and turns off when at logic high. The converter is on when the ON/OFF pin is either shorted to -INPUT pin or kept below 0.8V. The converter is off when the ON/OFF pin is either left open or external voltage greater than 2V and not more than 12V is applied between ON/OFF pin and -INPUT pin. See the Electrical Specifications for logic high/low definitions.

The ON/OFF pin is internally pulled up to typically 4.5V via resistor and connected to internal logic circuit via RC circuit in order to filter out noise that may occur on the ON/OFF pin. A properly de-bounced mechanical switch, open-collector transistor, or FET can be used to drive the input of the ON/OFF pin. The device must be capable of sinking up to 0.36mA at a low level voltage of  $\leq 0.8V$ . During logic high, the typical maximum voltage at ON/OFF pin (generated by the converter) is 4.5V, and the maximum allowable leakage current is 160 $\mu$ A. If not using the remote on/off feature leave the ON/OFF pin open.

TTL Logic Level - The range between 0.81V as maximum turn off voltage and 2V as minimum turn on voltage is considered the dead-band. Operation in the dead-band is not recommended.

External voltage for ON/OFF control should not be applied when there is no input power voltage applied to the converter.





# MTW Series, 360 Watt

DC/DC Converters

## Protection Features

### Input Undervoltage lockout (UVLO)

Input undervoltage lockout is standard with this converter. The converter will shut down when the input voltage drops below a pre-determined voltage.

The input voltage must be typically above 8.5V for the converter to turn on. Once the converter has been turned on, it will shut off when the input voltage drops typically below 8V. If the converter is started by input voltage (ON/OFF (pin 3) left open) there is typically 500msec delay from the moment when input voltage is above 8.5V turn-on voltage and the time when output voltage starts rising. This delay is intentionally provided to prevent potential startup issues especially at low input voltages.

### Output Overcurrent Protection (OCP)

The converter is protected against overcurrent or short circuit conditions. Upon sensing an overcurrent condition, the converter will switch to constant current operation and thereby begin to reduce output voltage. When the output voltage drops below approx. 75% of the nominal value of output voltage, the converter will shut down. Once the converter has shut down, it will attempt to restart nominally every 500msec with a typical 3% duty cycle. The attempted restart will continue indefinitely until the overload or short circuit conditions are removed or the output voltage rises above 75% of its nominal value.

Once the output current is brought back into its specified range, the converter automatically exits the hiccup mode and continues normal operation.

During initial startup, if output voltage does not exceed typical 75% of nominal output voltage within 20 msec after the converter is enabled, the converter will be shut down and will attempt to restart after 500 msec.

### Output Overvoltage Protection (OVP)

The converter will shut down if the output voltage across VOUT (+) (Pin 5) and VOUT (-) (Pin 9) exceeds the threshold of the OVP circuitry. The OVP circuitry contains its own reference, independent of the output voltage regulation loop. Once the converter has shut down, it will attempt to

restart every 500 msec until the OVP condition is removed.

### Over Temperature Protection (OTP)

The MTW converters have non-latching over temperature protection. It will shut down and disable the output if temperature at the center of the base plate exceeds a threshold of 114°C (typical).

The converter will automatically restart when the base temperature has decreased by approximately 20°C.

### Safety Requirements

Basic Insulation is provided between input and the output.

The converters have no internal fuse. To comply with safety agencies requirements, a fast-acting or time-delay fuse is to be provided in the unearthed lead.

Recommended fuse values are:

- a) 50A for  $9V < V_{IN} < 18V$
- b) 25A for  $18V < V_{IN} < 36V$

### Electromagnetic Compatibility (EMC)

EMC requirements must be met at the end-product system level, as no specific standards dedicated to EMC characteristics of board mounted component dc-dc converters exist.

With the addition of a single stage external filter, the MTW converters will pass the requirements of MIL-STD-461F CE102 Base Curve for conducted emissions.

### Absence of the Remote Sense Pins

Customers should be aware that MTW converters do not have a Remote Sense feature. Care should be taken to minimize voltage drop on the user's motherboard as well as if trim function is used.

### Output Voltage Adjust/TRIM (Pin 7)

The TRIM pin allows user to adjust output voltage 10% up or down relative to rated nominal voltage by addition of external trim resistor. Due to absence of Remote Sense Pins, an external trim resistor should be connected to output pins using Kelvin connection. If trimming is not used, the TRIM pin should be left open.



# MTW Series, 360 Watt

DC/DC Converters

## Trim Down – Decrease Output Voltage

Trimming down is accomplished by connecting an external resistor,  $R_{\text{TRIM-DOWN}}$ , between the TRIM (pin 7) and the VOUT(-) (pin 9) using Kelvin connection, with a value of:

$$R_{\text{TRIM-DOWN}} = 3010\Delta - 60.2 \text{ [k}\Omega\text{]}$$

Where,

$$R_{\text{TRIM-DOWN}} = \text{Required value of the trim-down resistor [k}\Omega\text{]}$$

$$V_o (\text{nom}) = \text{Nominal value of output voltage [V]}$$

$$V_o (\text{req}) = \text{Required value of output voltage [V]}$$

$$\Delta = \frac{V_o(\text{REQ}) - V_o(\text{NOM})}{V_o(\text{NOM})} \text{ [%]}$$

To trim the output voltage 10% ( $\Delta=10$ ) down, required external trim resistance is.

$$R_{\text{TRIM-DOWN}} = 301010 - 60.2 = 240.8 \text{ k}\Omega$$

## Trim Up – Increase Output Voltage

Trimming up is accomplished by connecting an external resistor,  $R_{\text{TRIM-UP}}$ , between the TRIM (pin 7) and the VOUT(+) (pin 5) using Kelvin connection, with a value of:

$$R_{\text{TRIM-UP}} = 30.1 * V_{\text{ONOM}} * (100 + \Delta) 1.225\Delta - (100 + 2\Delta)\Delta \text{ [k}\Omega\text{]}$$

To trim the output voltage up, for example 24V to 26.4V,  $\Delta=10$  and required external resistor is:

$$R_{\text{TRIM-UP}} = 30.1 * 24 * 100 + 101.225 * 10 - 100 + 2 * 1010 = 6125 \text{ k}\Omega$$

Note that trimming output voltage more than 10% is not recommended and OVP may be tripped.

## Active Voltage Programming

In applications where output voltage needs to be adjusted actively, an external voltage source, such as for example a Digital-to-Analog converter (DAC), capable of both sourcing and sinking current can be used. It should be connected with series resistor  $R_g$  across TRIM (pin 7) and VOUT(-) (pin 9) using Kelvin connection. Please contact Calex technical representative for more details.

## Thermal Consideration

The MTW converter can operate in a variety of thermal environments. However, in order to ensure reliable operation of the converter, sufficient cooling should be provided. The MTW converter is encapsulated in plastic case with metal baseplate on the top. In order to improve thermal performance, power components inside the unit are thermally coupled to the baseplate. In addition, thermal

design of the converter is enhanced by use of input and output pins as heat transfer elements. Heat is removed from the converter by conduction, convection and radiation.

There are several factors such as ambient temperature, airflow, converter power dissipation, converter orientation how converter is mounted as well as the need for increased reliability that need to be taken into account in order to achieve required performance. It is highly recommended to measure temperature in the middle of the baseplate in particular application to ensure that proper cooling of the convert is provided.

A reduction in the operating temperature of the converter will result in an increased reliability.

## Thermal Derating

There are two most common applications: 1) the MTW converter is thermally attached to a cold plate inside chassis without any forced internal air circulation; 2) the MTW converter is mounted in an open chassis on system board with forced airflow with or without an additional heatsink attached to the baseplate of the MTW converter.

The best thermal results are achieved in application 1) since the converter is cooled entirely by conduction of heat from the top surface of the converter to a cold plate and temperature of the components is determined by the temperature of the cold plate. There is also some additional heat removal through the converters pins to the metal layers in the system board. It is highly recommended to solder pins to the system board rather than using receptacles. Typical derating output power and current are shown in Figs. 10–15 for various baseplate temperatures up to 105°C. The converter was solder to the test card: 4.26" x 5.9" 4 layers FR4 PCB with 3Oz Cu inner layers and 2 Oz Cu outer layers, covered with solder mask. Note that operating converter at these limits for prolonged time will affect reliability.

## Soldering Guidelines

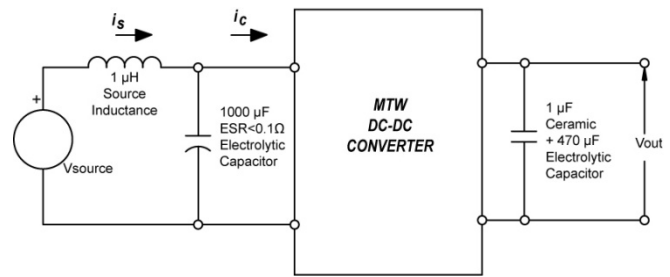
The ROHS-compliant through hole MTW converters use Sn/Ag/Cu Pb-free solder and ROHS compliant components. They are designed to be processed through wave soldering machines. The pins are 100% matte tin over nickel plated and compatible with both Pb and Pb-free wave soldering processes. It is recommended to follow specifications

below when installing and soldering MTW converters. Exceeding these specifications may cause damage to the MTW converter.

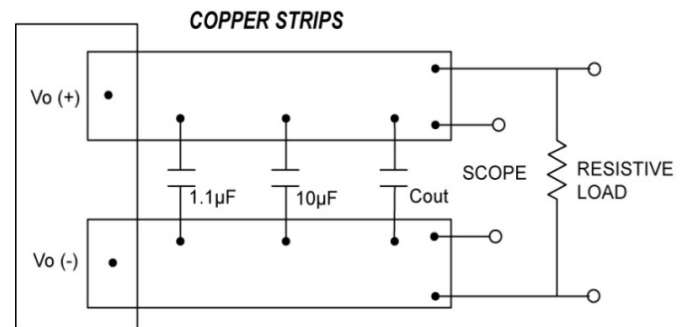
Wave Solder Guideline for Sn/Ag/Cu based solders	
Maximum Preheat Temperature	115 °C
Maximum Pot Temperature	270 °C
Maximum Solder Dwell Time	7 seconds

Wave Solder Guideline for SN/Pb based solders	
Maximum Preheat Temperature	105 °C
Maximum Pot Temperature	250 °C
Maximum Solder Dwell Time	6 seconds

MTW converters are not recommended for water wash process. Contact the factory for additional information if water wash is necessary.



**Fig. 2:** Test setup for measuring input reflected ripple currents  $i_c$  and  $i_s$ .



**Fig. 3:** Test setup for measuring output voltage ripple, startup and step load transient waveforms.

### Characteristic Curves – Efficiency and Power Dissipation

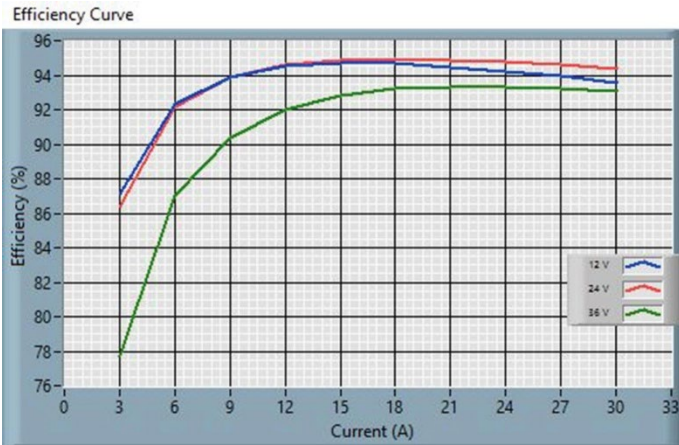


Fig. 4: 24S12.30MTW (ROHS) Efficiency Curve

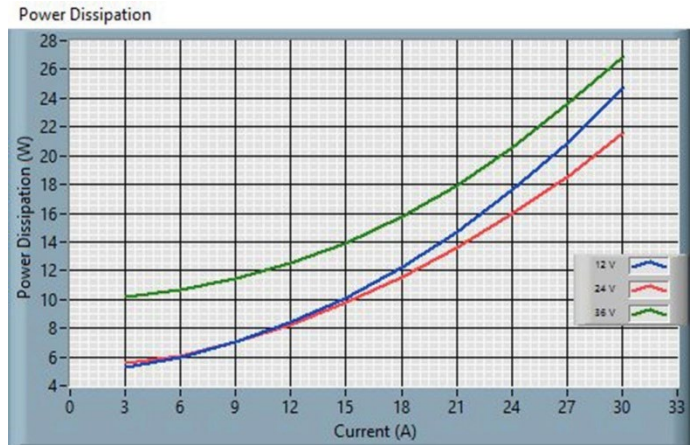


Fig. 5: 24S12.30MTW (ROHS) Power Dissipation

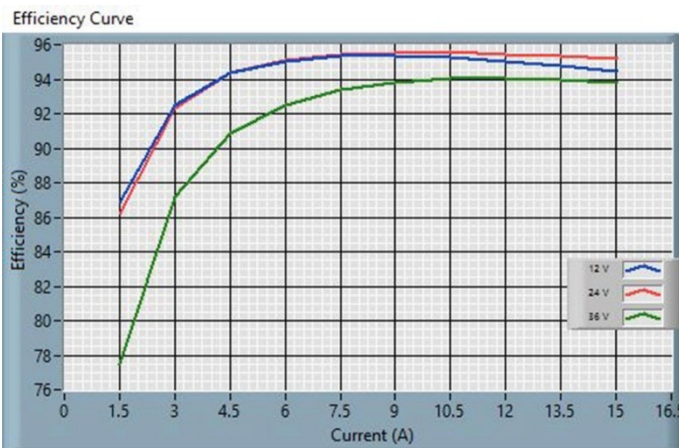


Fig. 6: 24S24.15MTW (ROHS) Efficiency Curve

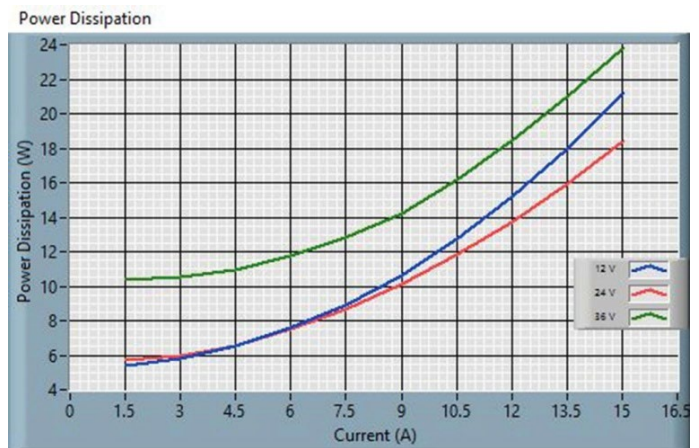


Fig. 7: 24S24.15MTW (ROHS) Power Dissipation

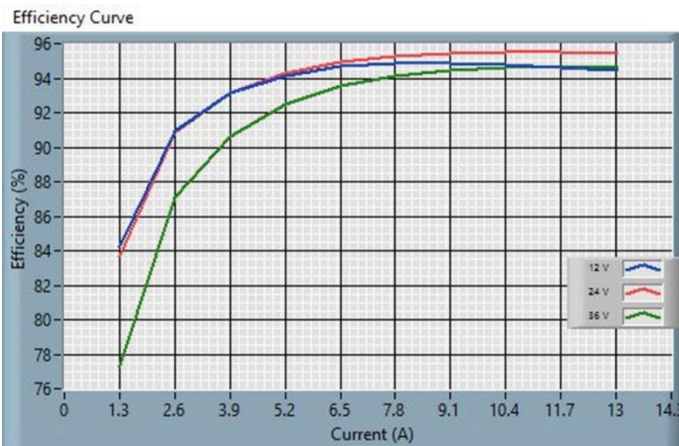


Fig. 8: 24S28.13MTW (ROHS) Efficiency Curve

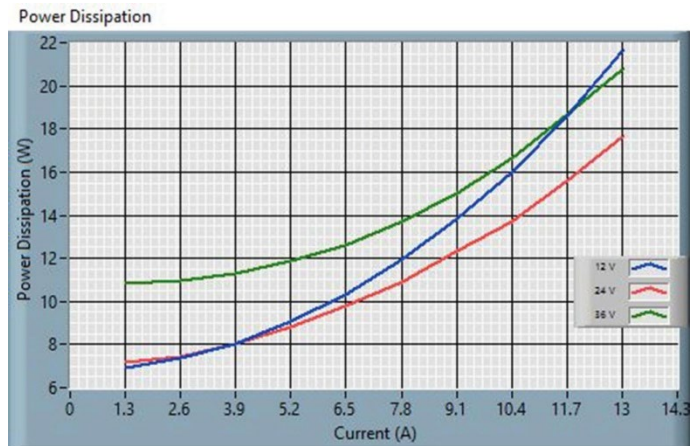
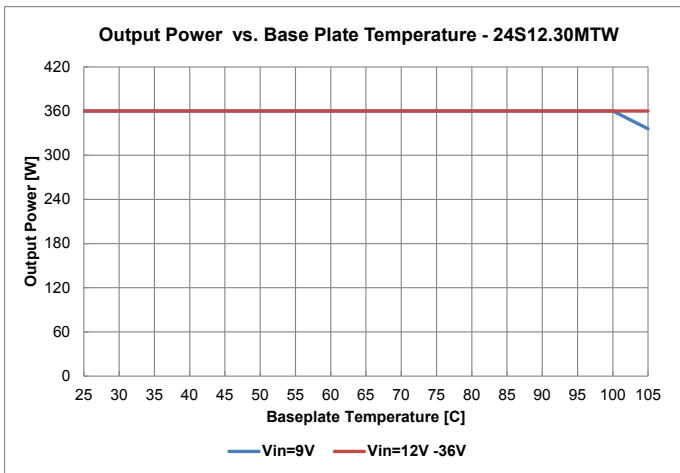
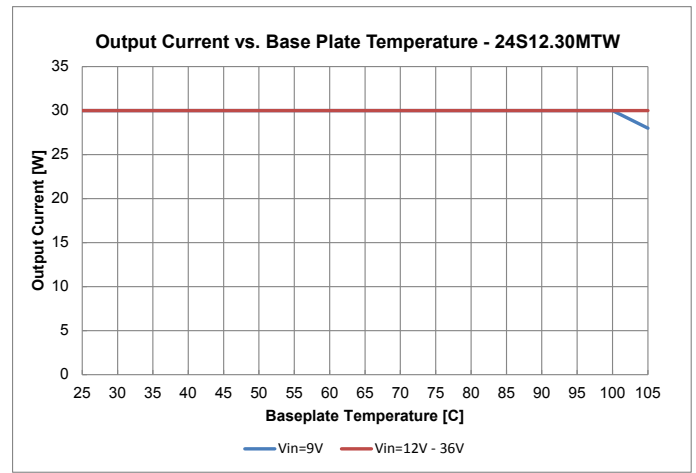


Fig. 9: 24S28.13MTW (ROHS) Power Dissipation

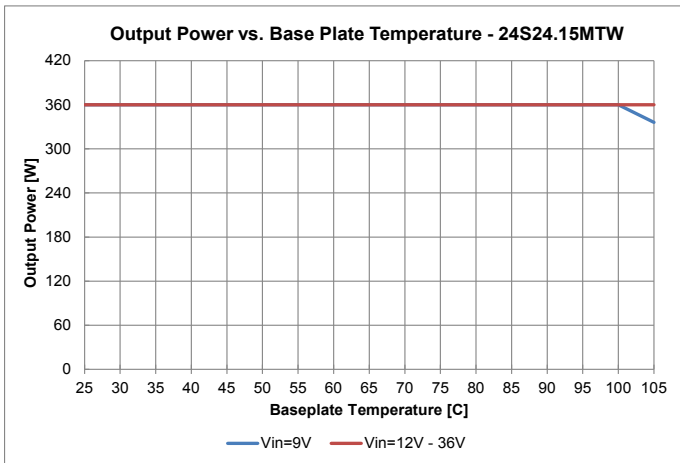
### Characteristic Curves – Derating vs. Baseplate Temperature



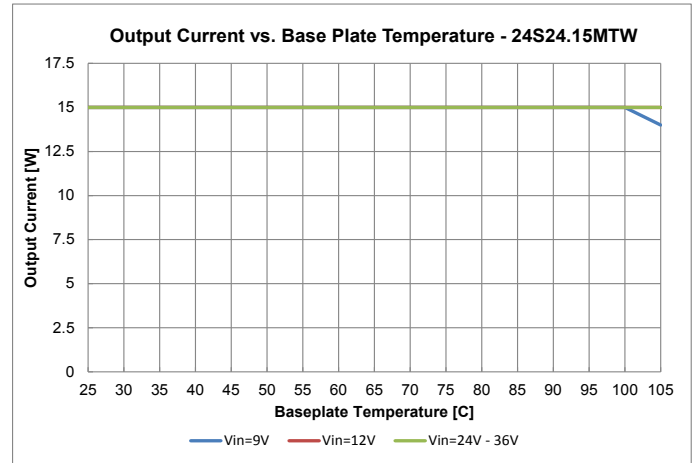
**Fig. 10:** 24S12.30MTW (ROHS) Derating Curve



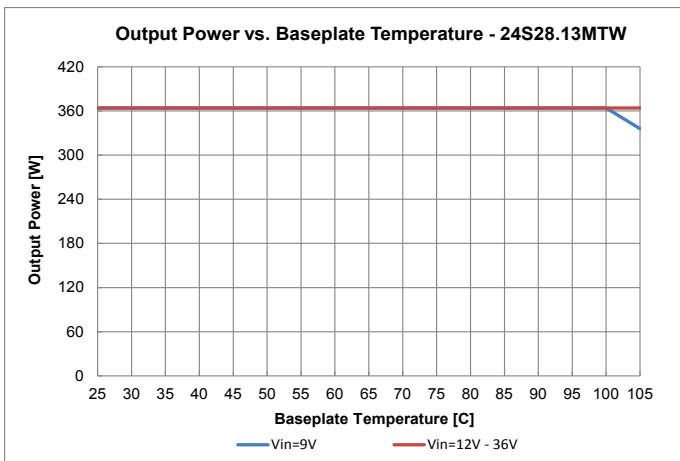
**Fig. 11:** 24S12.30MTW (ROHS) Derating Curve



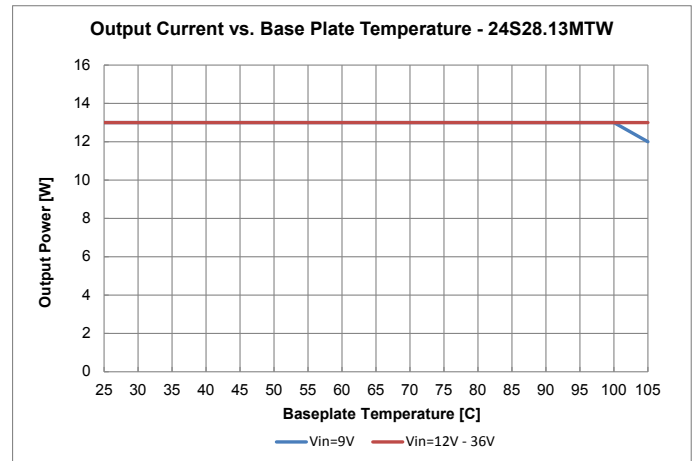
**Fig. 12:** 24S24.15MTW (ROHS) Derating Curve



**Fig. 13:** 24S24.15MTW (ROHS) Derating Curve

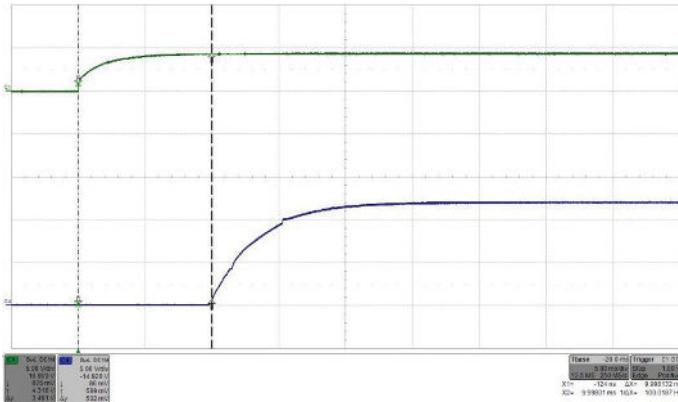


**Fig. 14:** 24S28.13MTW (ROHS) Derating Curve

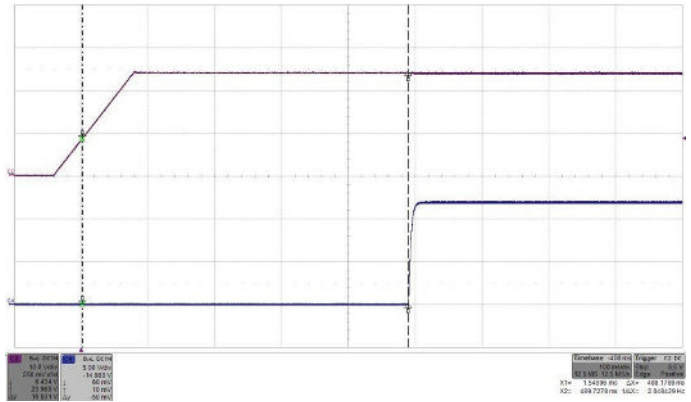


**Fig. 15:** 24S28.13MTW (ROHS) Derating Curve

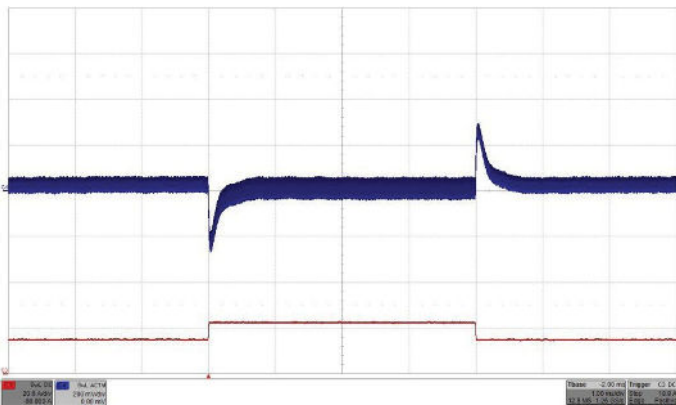
### Characteristic Waveforms – 24S12.30MTW (ROHS)



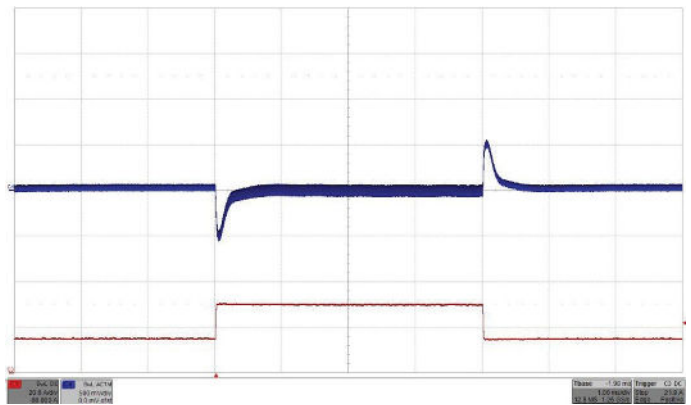
**Fig. 16:** Turn-on by ON/OFF transient (with VIN applied) at full rated load current (resistive) at VIN = 24V. Top trace (C1): ON/OFF signal (5V/div.). Bottom trace (C4): Output voltage (5 V/div.). Time 5 ms/div.



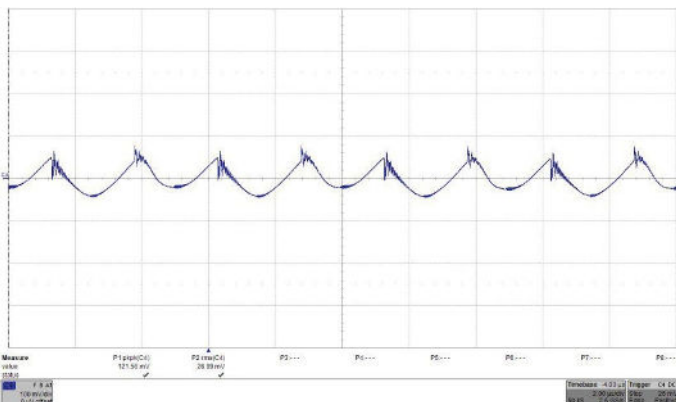
**Fig. 17:** Turn-on by VIN (ON/OFF high) transient at full rated load current (resistive) at VIN = 24V. Top trace (C2): Input voltage VIN (10 V/div.). Bottom trace (C4): Output voltage (5 V/div.). Time 100 ms/div.



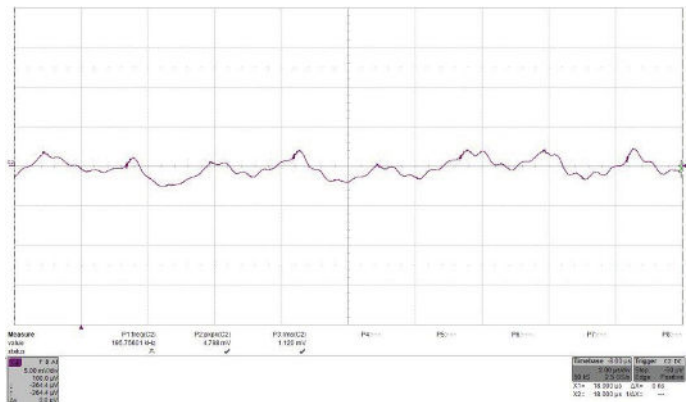
**Fig. 18:** Output voltage response to load current step change 50% - 75% - 50% (15A – 22.5A – 15A) with  $di/dt = 1A/\mu s$  at VIN = 24V. Top trace (C4): Output voltage (200 mV/div.). Bottom trace (C3): Load current (20A/div.).  $C_o = 470\mu F/70m\Omega$ . Time: 1ms/div.



**Fig. 19:** Output voltage response to load current step change 50% - 100% - 50% (15A – 30A – 15A) with  $di/dt = 1A/\mu s$  at VIN = 24V. Top trace (C4): Output voltage (500 mV/div.). Bottom trace (C3): Load current (20A/div.).  $C_o = 470\mu F/70m\Omega$ . Time: 1ms/div.

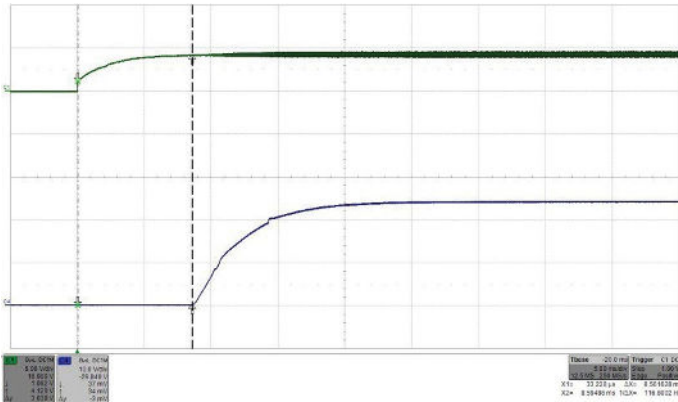


**Fig. 20:** Output voltage ripple (100mv/div.) at full rated load current into a resistive load at VIN = 24V.  $C_o = 470\mu F/70m\Omega$ . Time: 2 $\mu s$ /div.

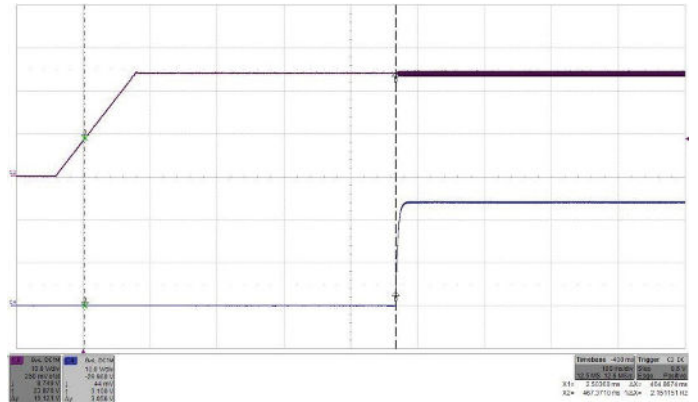


**Fig. 21:** Input reflected ripple current,  $i_C$  (500 mA/mV), measured at input terminals at full rated load current at VIN = 24V. Refer to Fig. 2 for test setup. Time: 2  $\mu s$ /div. RMS input ripple current is  $1.125 \cdot 500mA = 560mA$ .

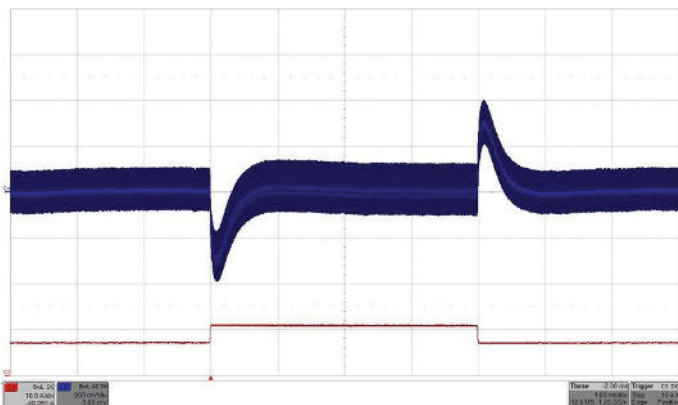
### Characteristic Waveforms – 24S24.15MTW (ROHS)



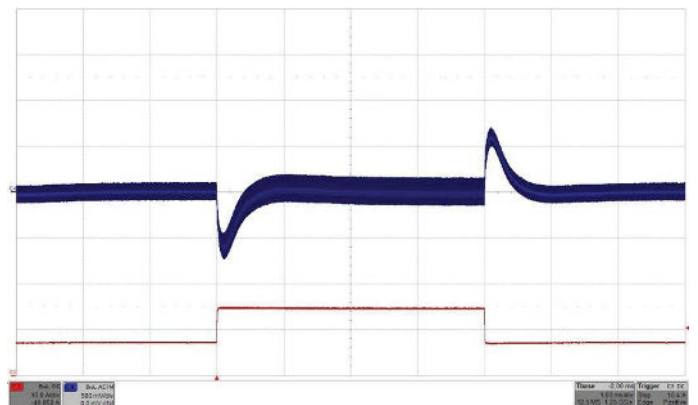
**Fig. 22:** Turn-on by ON/OFF transient (with VIN applied) at full rated load current (resistive) at VIN = 24V. Top trace (C1): ON/OFF signal (5V/div.). Bottom trace (C4): Output voltage (10 V/div.). Time 5 ms/div.



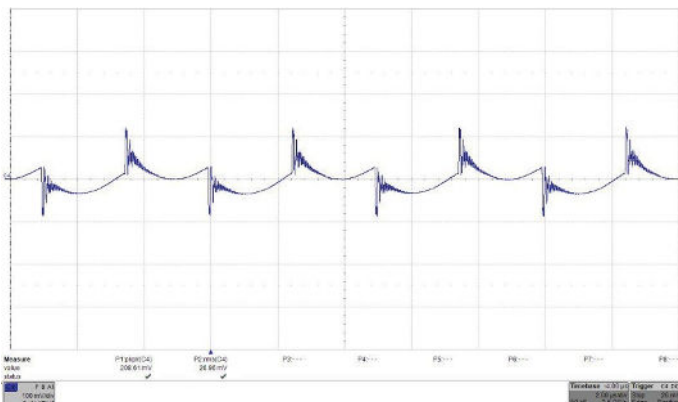
**Fig. 23:** Turn-on by VIN transient (ON/OFF high) at full rated load current (resistive) at VIN = 24V. Top trace (C2): Input voltage VIN (10 V/div.). Bottom trace (C4): Output voltage (10 V/div.). Time 100 ms/div.



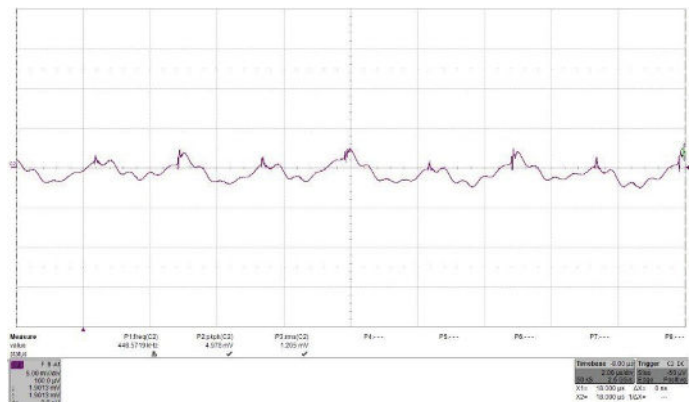
**Fig. 24:** Output voltage response to load current step change 50% - 75% - 50% (7.5A – 11.25A – 7.5A) with  $di/dt = 1A/\mu s$  at VIN = 24V. Top trace (C4): Output voltage (200 mV/div.). Bottom trace (C3): Load current (10A/div.).  $C_o$  470 $\mu$ F/70m $\Omega$ . Time: 1ms/div.



**Fig. 25:** Output voltage response to load current step change 50% - 100% - 50% (7.5A – 15A – 7.5A) with  $di/dt = 1A/\mu s$  at VIN = 24V. Top trace (C4): Output voltage (500 mV/div.). Bottom trace (C3): Load current (10A/div.).  $C_o$  470 $\mu$ F/70m $\Omega$ . Time: 1ms/div.

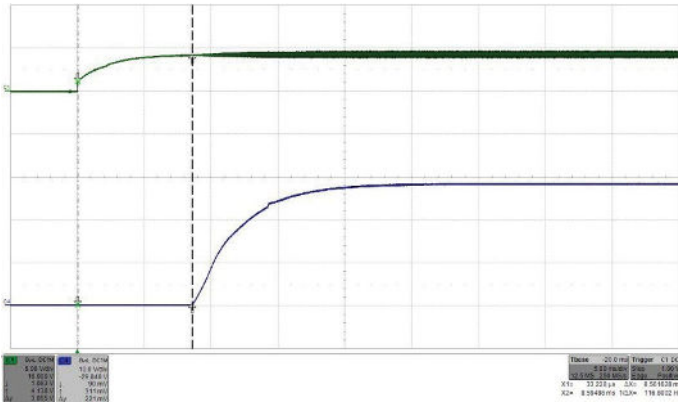


**Fig. 26:** Output voltage ripple (200mv/div.) at full rated load current into a resistive load at VIN = 24V.  $C_o$  470 $\mu$ F/70m $\Omega$ . Time: 2 $\mu$ s/div.

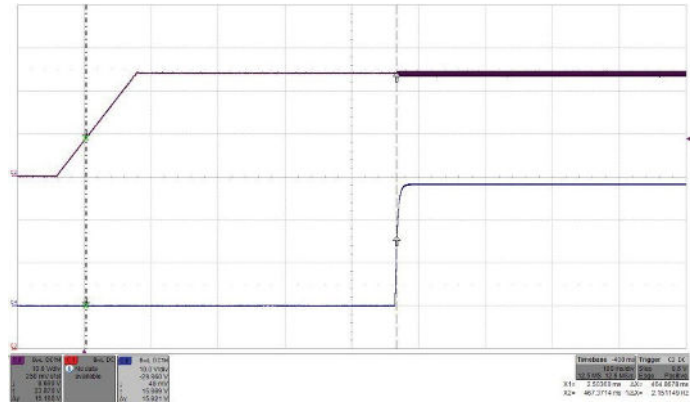


**Fig. 27:** Input reflected ripple current,  $i_C$  (500 mA/mV), measured at input terminals at full rated load current at VIN = 24V. Refer to Fig. 2 for test setup. Time: 2  $\mu$ s/div. RMS input ripple current is 1.205\*500mA = 602.5mA.

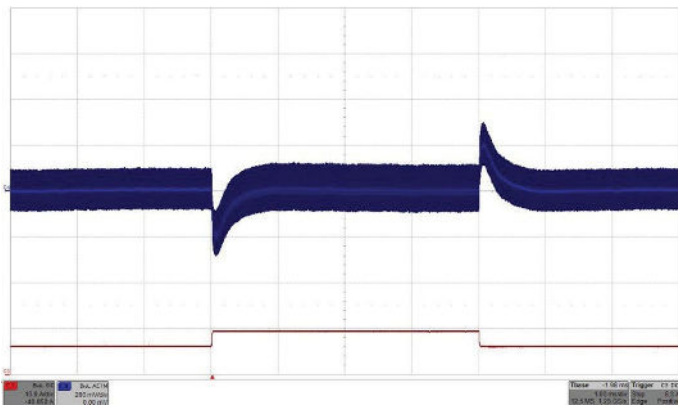
### Characteristic Waveforms – 24S28.13MTW (ROHS)



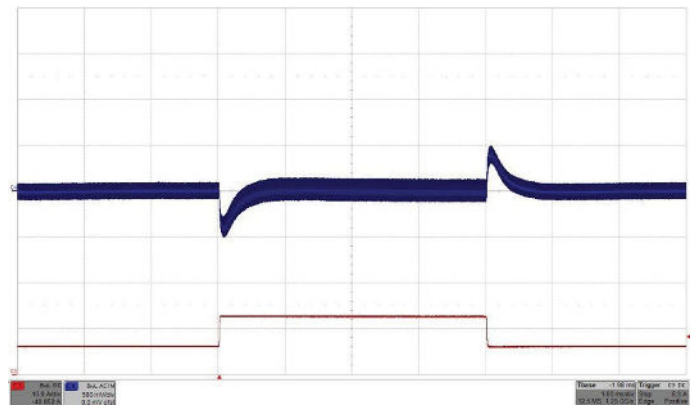
**Fig. 28:** Turn-on by ON/OFF transient (with VIN applied) at full rated load current (resistive) at VIN = 24V. Top trace (C1): ON/OFF signal (5V/div.). Bottom trace (C4): Output voltage (10 V/div.). Time 5 ms/div.



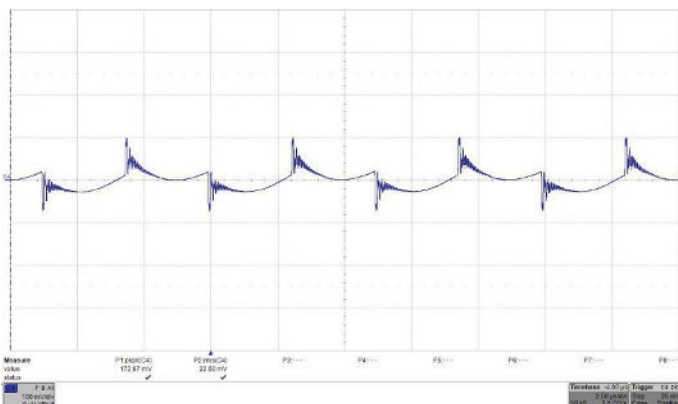
**Fig. 29:** Turn-on by VIN transient (ON/OFF high) at full rated load current (resistive) at VIN = 24V. Top trace (C2): Input voltage VIN (10 V/div.). Bottom trace (C4): Output voltage (10 V/div.). Time 100 ms/div.



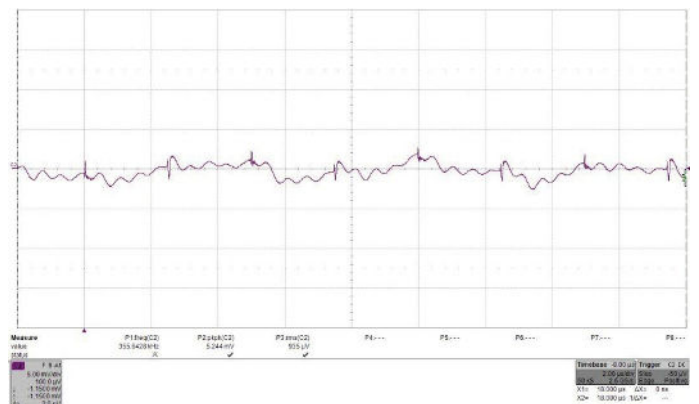
**Fig. 30:** Output voltage response to load current step change 50% - 75% - 50% (6.5A – 9.75A – 6.5A) with di/dt = 1A/μs at VIN = 24V. Top trace (C4): Output voltage (200 mV/div.). Bottom trace (C3): Load current (10A/div.). C<sub>o</sub> 470μF/70mΩ. Time: 1ms/div.



**Fig. 31:** Output voltage response to load current step change 50% - 100% - 50% (6.5A – 13A – 6.5A) with di/dt = 1A/μs at VIN = 24V. Top trace (C4): Output voltage (500 mV/div.). Bottom trace (C3): Load current (10A/div.). C<sub>o</sub> 470μF/70mΩ. Time: 1ms/div.



**Fig.32:** Output voltage ripple (200mv/div.) at full rated load current into a resistive load at VIN = 24V. C<sub>o</sub> 470μF/70mΩ. Time: 2μs/div.



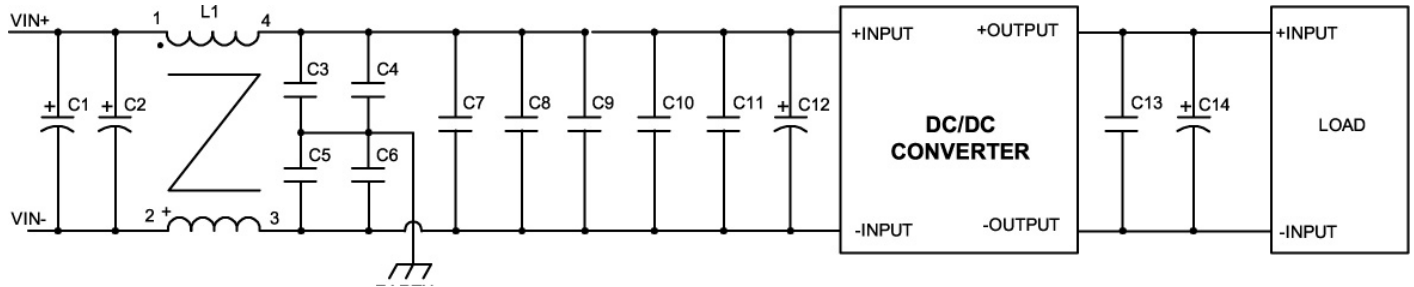
**Fig. 33:** Input reflected ripple current, i<sub>C</sub> (500 mA/mV), measured at input terminals at full rated load current at VIN = 24V. Refer to Fig. 2 for test setup. Time: 2 μs/div. RMS input ripple current is 0.935\*500mA = 549mA.



### EMC Consideration

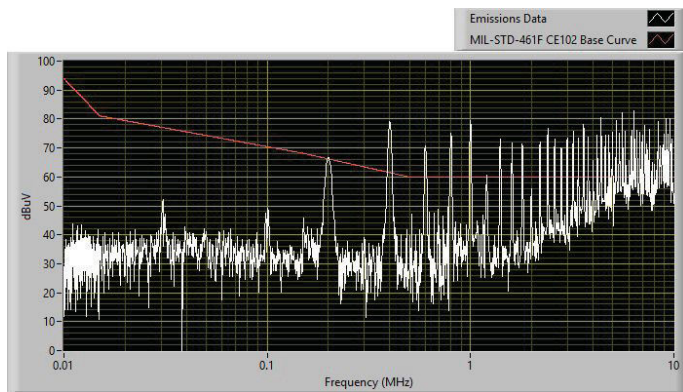
The filter schematic for suggested input filter configuration as tested to meet the conducted emission limits of MIL-STD-461F CE102 Base Curve is shown in Fig.34. The plots of conducted EMI spectrum are shown in Fig. 35.

Note: Customer is ultimately responsible for the proper selection, component rating and verification of the suggested parts based on the end application.

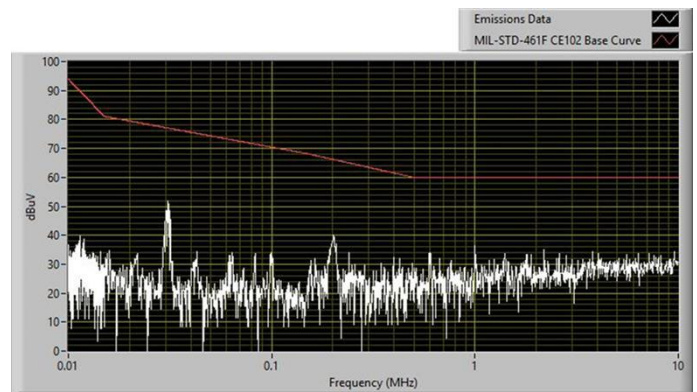


Comp. Des.	Description
C1, C2, C12, C14	470 $\mu$ F/50V/70m $\Omega$ Electrolytic Capacitor (Vishay MAL214699108E3 or equivalent)
C3, C4, C5, C6	4.7nF/1210/X7R/1500V Ceramic Capacitor
C7, C8, C9, C10, C11, C13	10 $\mu$ F/1210/X7R/50V Ceramic Capacitor
L1	CM choke: L = 130 $\mu$ H, L <sub>lkg</sub> = 0.6 $\mu$ H (4 turns on toroid 22.1mm x 13.7mm x 7.92mm)

**Fig.34:** Typical input EMI filter circuit to attenuate conducted emissions per MIL-STD-461F CE102 Base Curve.



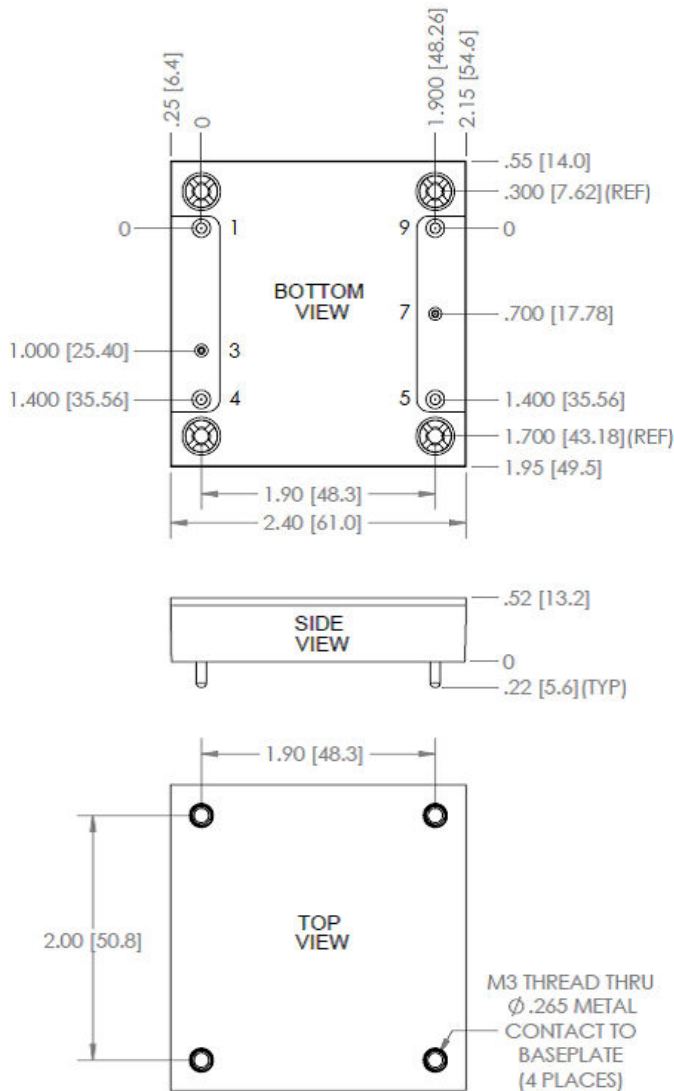
**a)** Without input filter. C<sub>IN</sub> = 2 x 470 $\mu$ F/50V/70m $\Omega$ .



**b)** With input filter from Fig. 28.

**Fig. 35:** Input conducted emissions measurement (Typ.) of 24S24.15MTW (ROHS)

### Mechanical Specification



### Input Output Connections:

Pin	Name	Function
1	-INPUT	Negative input voltage
3	ON/OFF	TTL input with internal pull up, referenced to -INPUT, used to turn converter on and off
4	+INPUT	Positive input voltage
5	+OUTPUT	Positive output voltage
7	TRIM	Output voltage trim
9	-OUTPUT	Negative output voltage

#### Notes:

- Pinout is inconsistent between manufacturers of the half brick converters. Make sure to follow the pin function, the pin number, when laying out your board.
- Pin diameter for the input pins of the MTW converters has diameter 0.081" due to high current at low line, and is different from other manufacturers of the half brick. Make sure to follow pin dimensions in your application.

#### NOTES:

Unless otherwise specified:

All dimensions are in inches [millimeters]

Tolerances: x.xx in.  $\pm 0.02$  in [x.x mm  $\pm 0.5$ mm]

x.xxx in.  $\pm 0.010$  in [x.xx mm  $\pm 0.25$ mm]

Torque fasteners into threaded mounting inserts at 10in.lbs. or less. Greater torque may result in damage to unit and void the warranty.