

Non-isolated & regulated 6A single output
POL power converter



K12T-6A series is a 6A non-isolated switching regulator. The output voltage is accurately adjustable from 0.75V to 5.0V, and the product is featured with high efficiency, fast transient response, input under-voltage, output short circuit, over-current protection. They meet CLASS B of CISPR32/EN55032 EMI standards by adding the recommended external components and they are widely used in applications such as communications, computer network industry, power distributed architecture, workstations, servers, LANs/WANs and provide high current with fast transient response for high-speed chips such as FPGA, DSP, and ASIC.

FEATURES

- High efficiency up to 94%
- Operating ambient temperature range: -40°C to +85°C
- Input under-voltage protection, output short-circuit, over-current protection
- High-speed transient response
- Compact SMD package
- EN62368 approved

Selection Guide

Certification	Part No. ^①	Input Voltage (VDC)		Output		Efficiency(%) Min./Typ.	Capacitive Load(μF) Max.	
		Nominal (Range)	Max. ^②	Voltage(VDC) ^③ (Range)	Current (A) Max./Min.		1mΩ ≤ ESR < 10 mΩ	ESR ≥ 10 mΩ
CE	K12T-6A-P	12	15	0.75~5.0	6/0	90/94	1000	3000
	K12T-6A-N	(8.3~14)						

Notes: ① "P" indicates that the Ctrl pin is positive logic control, "N" indicates that the Ctrl pin is negative logic control;

② Exceeding the maximum input voltage may cause permanent damage;

③ The default output voltage is 0.75VDC, which can be adjusted to 1.2VDC, 1.8VDC, 2.5VDC, 3.3VDC, 5VDC. See Trim instructions for specific output voltage adjustment;

④ Unless otherwise specified, parameters in this table were measured under the 5VDC output voltage.

Input Specifications

Item	Operating Conditions	Min.	Typ.	Max.	Unit
Input Current (full load/no-load)	Nominal input voltage	--	2660/20	--	mA
Start-up Voltage		--	--	8	VDC
Under-voltage Protection		6	--	--	
Reverse Polarity Input		Avoid / Not protected			
Hot Plug		Unavailable			
Input Filter		Capacitance filter			
Ctrl*	Module on	K12T-6A-P (Positive logic)		Ctrl pin open or pulled high (Vin-2.5V ~ Vin)	
		K12T-6A-N (Negative logic)		Ctrl pin open or pulled low to GND (0 ~ 0.5VDC)	
	Module off	K12T-6A-P (Positive logic)		Ctrl pin pulled low to GND (0 ~ 0.5VDC)	
		K12T-6A-N (Negative logic)		Ctrl pin pulled high (Vin-2.5V ~ Vin)	
	Input current when off	--	1	--	mA

Notes: * 1. The Ctrl pin voltage is referenced to GND;

2. Unless otherwise specified, parameters in this table were measured under the 5VDC output voltage.

Output Specifications

Item	Operating Conditions	Min.	Typ.	Max.	Unit
Voltage Accuracy	Full load, nominal input voltage	--	±1.0	±2.0	%
Linear Regulation	Full load, input voltage range	--	±0.3	--	
Load Regulation	Nominal input, 0% -100% load	--	±0.4	--	

Ripple & Noise*	20MHz bandwidth, nominal input, 100% load	--	35	75	mVp-p
Trim		0.75	--	5.0	VDC
Temperature Coefficient	100% load	--	±0.02	--	%/°C
Transient Response Deviation	Nominal input, 50%-100%-50% load step change, di/dt=2.5A/us, with external 2 x 150 μF polymer capacitors	--	±70	--	mV
Transient Recovery Time		--	20	--	us
Over-current Protection	Nominal input	140	160	--	%Io
Short-circuit Protection	Nominal input	Continuous, self-recovery			

Notes: * 1. The "parallel cable" method is used for Ripple and Noise test, please refer to DC-DC Converter Application Notes for specific information;
2. Unless otherwise specified, parameters in this table were measured under the 5VDC output voltage.

General Specifications

Item	Operating Conditions	Min.	Typ.	Max.	Unit
Operating Temperature	See Fig. 1	-40	--	+85	°C
Storage Temperature		-55	--	+125	
Storage Humidity	Non-condensing	5	--	95	%RH
Reflow Soldering Temperature		Peak temp. Tc ≤245°C, maximum duration time ≤60s over 217°C. For actual application, please refer to IPC/JEDEC J-STD-020D.1.			
Switching Frequency	Full load, nominal input voltage input	--	350	--	kHz
MTBF	MIL-HDBK-217F@25°C	1000	--	--	k hours

Mechanical Specifications

Dimensions	20.30 x 11.40 x 6.60 mm
Weight	3.9g (Typ.)
Cooling Method	Nature convection or forced convection

Electromagnetic Compatibility (EMC)

Emissions	CE	CISPR32/EN55032 Class B (see Fig.3 for recommended circuit)		
	RE	CISPR32/EN55032 Class B (see Fig.3 for recommended circuit)		
Immunity	ESD	IEC/EN61000-4-2	Contact ±6kV	perf. Criteria B

Typical Characteristic Curves

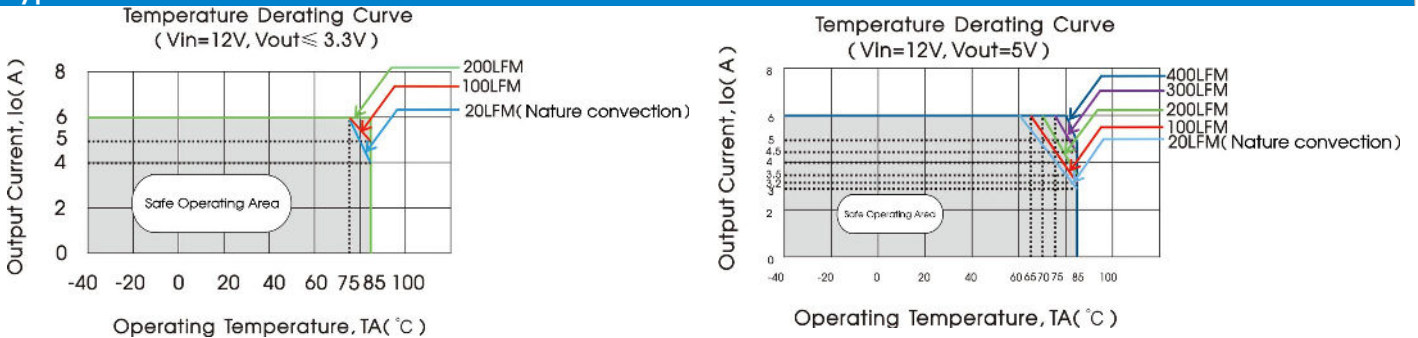
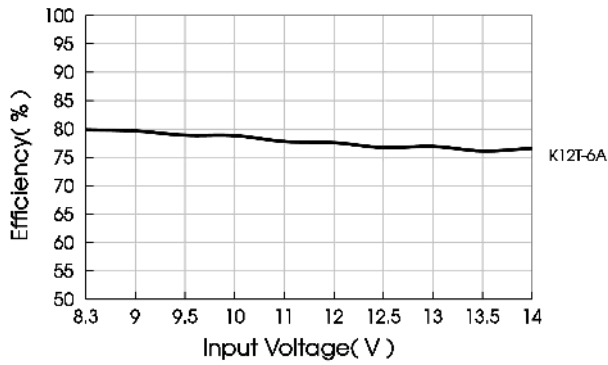
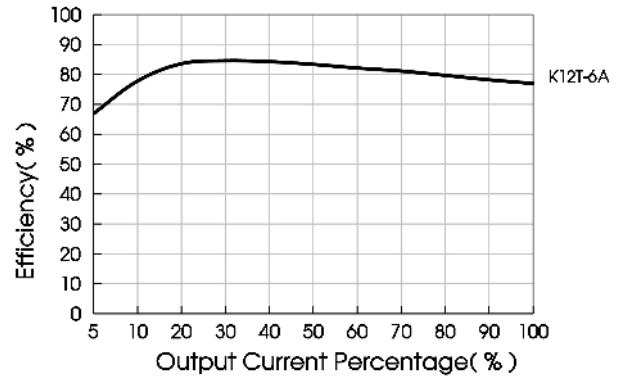

Fig. 1

Efficiency Vs input Voltage
($V_{out}=0.75V, I_o=6A$)



Efficiency Vs Output Load
($V_{in}=12V, V_{out}=0.75V$)



Efficiency Vs input Voltage
($V_{out}=3.3V, I_o=6A$)

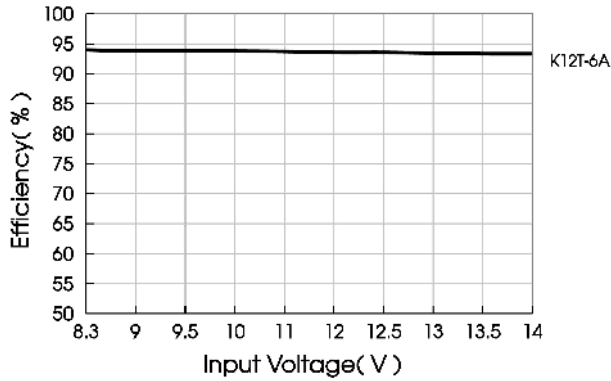

Efficiency Vs Output Load
($V_{in}=12V, V_{out}=3.3V$)

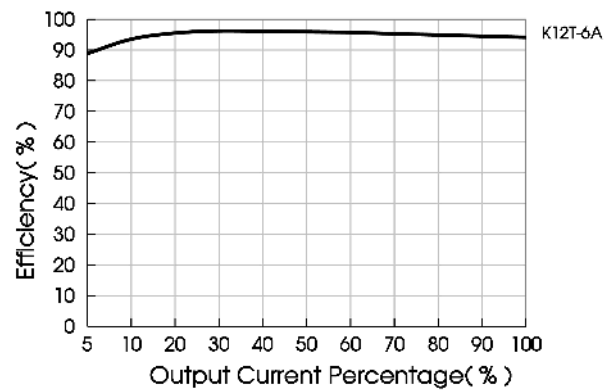

Efficiency Vs Input Voltage
($V_{out}=5V, I_o=6A$)

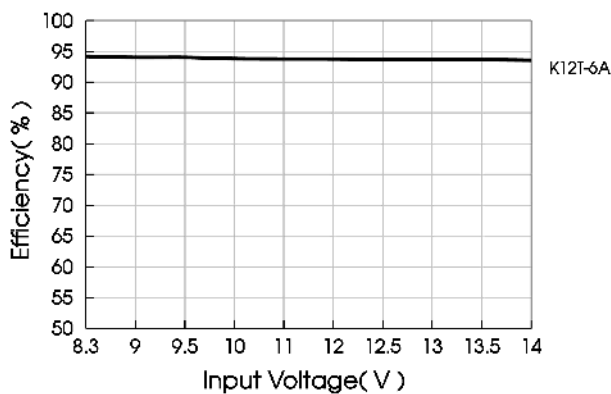

Efficiency Vs Output Load
($V_{in}=12V, V_{out}=5V$)

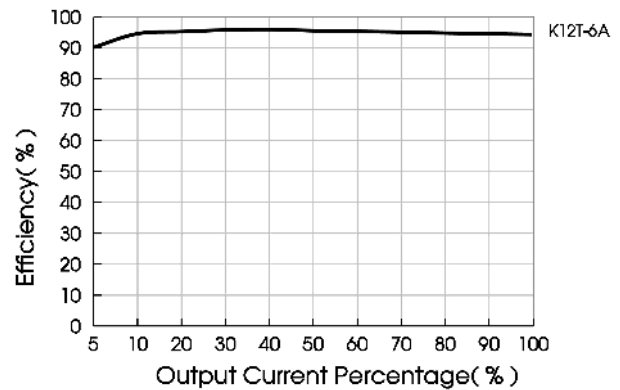

Design Reference

1. Typical application

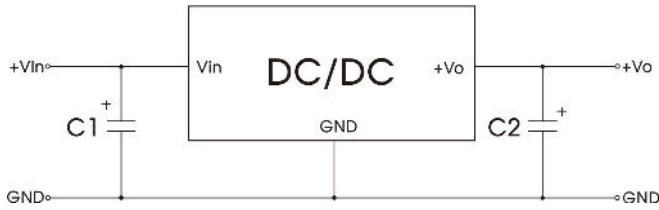

Fig. 2

Notes:

1. 100 μF polymer capacitors (C1) is required and should be connected close to the pin terminal, to ensure the stability of the converter;
2. To reduce the output ripple furtherly, increased values and/or tantalum or low ESR electrolytic capacitors may also be used instead;
3. Refer to Table 1 for C1 and C2 capacitor values;
4. Converter cannot be used for hot swap and with output in parallel.

2. EMC compliance circuit

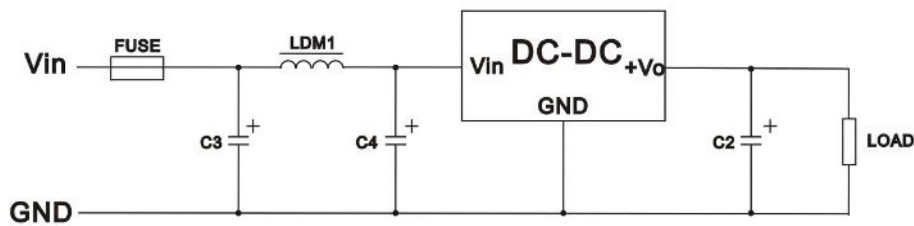

Fig. 3

Table 2

FUSE	C3/C4	LDM1	C2
Selected based on the actual input current in application	100μF /35V	6.8μH	Refer to the Cout in Table 1

3. Trim function for output voltage adjustment (open if unused)

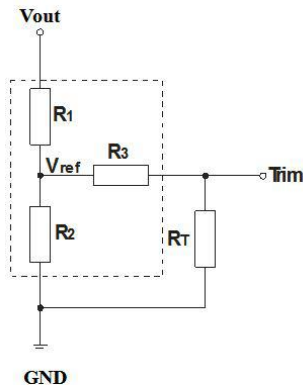

Fig. 4 TRIM resistor connection (dashed line shows internal resistor network)

Table 3

Vo(VDC)	R _T (kΩ)
0.7525	Open
1.2	15.089
1.8	5.873
2.5	3.120
3.3	1.826
5	0.695

Calculating Trim resistor (R_T) values:

$$R_T(\Omega) = \frac{7200}{V_o - 0.7525} - 1000$$

- Notes: 1. R_T : Resistance of Trim; Vo: The trim up voltage;
2. If R_T = ∞ or Trim pin open, Vo = 0.7525 VDC.

4. For additional information please refer to DC-DC converter application notes on

www.mornsun-power.com

Dimensions and Recommended Layout

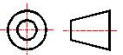
THIRD ANGLE PROJECTION 

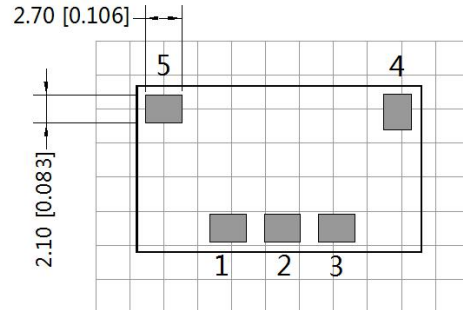
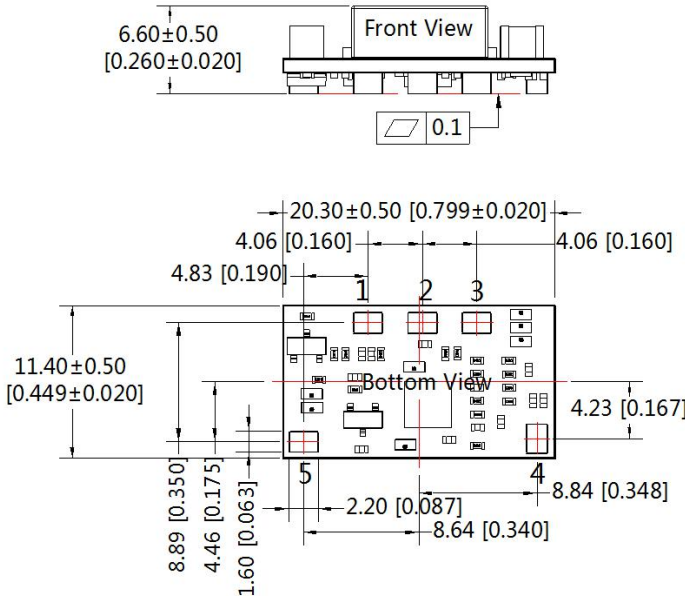

Note: Grid 2.54*2.54mm

Pin-Out	
Pin	Mark
1	GND
2	Trim
3	+Vo
4	Ctrl
5	Vin

Note:
Unit: mm[inch]
General tolerances: $\pm 0.25[\pm 0.010]$
The layout of the device is for reference only ,
please refer to the actual product

Notes:

- For additional information on Product Packaging please refer to www.mornsun-power.com. Packaging bag number: 58210072;
- The maximum capacitive load offered were tested at input voltage range and full load;
- Unless otherwise specified, parameters in this datasheet were measured under the conditions of $T_a=25^\circ\text{C}$, humidity<75%RH with nominal input voltage, 5VDC output voltage and rated output load;
- All index testing methods in this datasheet are based on company corporate standards;
- We can provide product customization service, please contact our technicians directly for specific information;
- Products are related to laws and regulations: see "Features" and "EMC";
- Our products shall be classified according to ISO14001 and related environmental laws and regulations, and shall be handled by qualified units.

MORNSUN Guangzhou Science & Technology Co., Ltd.

Address: No. 5, Kehui St. 1, Kehui Development Center, Science Ave., Guangzhou Science City, Huangpu District, Guangzhou, P. R. China
Tel: 86-20-38601850 Fax: 86-20-38601272 E-mail: info@mornsun.cn www.mornsun-power.com