

2W isolated DC-DC converter with Fixed input voltage,
& Unregulated Single Output



FEATURES

- Operating ambient temperature range: -40°C to +105°C
- High efficiency up to 84%
- Compact SMD package
- I/O isolation test voltage 1.5k VDC
- Internal surface mount design
- No external components required
- Industry standard pin-out
- EN60950 approval

B_XT-2WR2 series is designed for use in distributed power supply systems and especially suitable in applications such as pure digital circuits, low frequency analog circuits, noise and interference cancelling circuits, relay-driven circuits and data switching circuits, where

1. The voltage of the input power supply is relatively stable with a variation of $\pm 10\%V_{in}$ or less;
2. An input to output isolation voltage of up to 1500VDC is necessary;
3. The requirement for ripple & noise or a tight output regulation is not as strict.

Selection Guide

Certification	Part No.	Input Voltage (VDC)	Output		Full Load Efficiency (%) Min./Typ.	Capacitive Load(μF) Max.
		Nominal (Range)	Voltage (VDC)	Current(mA) Max./Min.		
CE	B0503XT-2WR2	5 (4.5-5.5)	3.3	400/40	68/72	220
	B0505XT-2WR2		5	400/40	75/79	
	B0509XT-2WR2		9	222/22	78/82	
	B0512XT-2WR2		12	167/17	78/82	
	B0515XT-2WR2		15	133/13	79/83	
	B1205XT-2WR2	12 (10.8-13.2)	5	400/40	75/79	
	B1209XT-2WR2		9	222/22	78/82	
	B1212XT-2WR2		12	167/17	78/82	
	B1215XT-2WR2		15	133/13	79/83	
	B1224XT-2WR2		24	83/8	80/84	
--	B1505XT-2WR2	15 (13.5-16.5)	5	400/40	73/77	
CE	B1515XT-2WR2	24 (21.6-26.4)	15	133/13	79/83	
	B2405XT-2WR2		5	400/40	75/79	
	B2409XT-2WR2		9	222/22	78/82	
	B2412XT-2WR2		12	167/17	78/82	
	B2415XT-2WR2		15	133/13	79/83	
	B2424XT-2WR2		24	83/8	80/84	

Input Specifications

Item	Operating Conditions	Min.	Typ.	Max.	Unit
Input Current (full load / no-load)	5V input	--	506/30	--/60	mA
	12V input	--	212/25	--/50	
	15V input	--	169/18	--/35	
	24V input	--	105/15	--/30	
Reflected Ripple Current*		--	15	--	
Surge Voltage (1sec. max.)	5V input	-0.7	--	9	VDC
	12V input	-0.7	--	18	
	15V input	-0.7	--	21	
	24V input	-0.7	--	30	

Input Filter		Capacitance filter
Hot Plug		Unavailable

Note: * Please refer to DC-DC Converter Application Note for detailed description of Reflected ripple current testing method.

Output Specifications

Item	Operating Conditions		Min.	Typ.	Max.	Unit
Voltage Accuracy			See output regulation curve (Fig. 1)			
Linear Regulation	Input voltage change: ±1%	3.3VDC output	--	--	±1.5	--
		Other output	--	--	±1.2	
Load Regulation	10%-100% load	3.3VDC output	--	18	--	%
		5VDC output	--	12	--	
		9VDC output	--	9	--	
		12VDC output	--	8	--	
		15VDC output	--	7	--	
		24VDC output	--	6	--	
Ripple & Noise*	20MHz bandwidth	24VDC output	--	100	200	mVp-p
		Other output	--	100	150	
Temperature Coefficient	Full load		--	--	±0.03	%/°C
Short Circuit Protection**			--	--	1	s

Note: * The "parallel cable" method is used for Ripple and noise test, please refer to DC-DC Converter Application Notes for specific information;
 ** At the end of the short circuit duration, the supply voltage must be disconnected from the modules.

General Specifications

Item	Operating Conditions		Min.	Typ.	Max.	Unit
Isolation	Input-output electric strength test for 1 minute with a leakage current of 1mA max.		1500	--	--	VDC
Insulation Resistance	Input-output resistance at 500VDC		1000	--	--	MΩ
Isolation Capacitance	Input-output capacitance at 100kHz/0.1V		--	20	--	pF
Operating Temperature	3.3V/5V output	Derating when operating temperature ≥ 71°C, (see Fig. 2)	-40	--	105	°C
	Other output	Derating when operating temperature ≥ 85°C, (see Fig. 2)				
Storage Temperature			-55	--	125	
Case Temperature Rise	Ta=25°C		--	25	--	
Storage Humidity	Non-condensing		--	--	95	%RH
Reflow Soldering Temperature			Peak temp. ≤245°C, maximum duration time ≤60s over 217°C. For actual application, please refer to IPC/JEDEC J-STD-020D.1.			
Switching Frequency	Full load, nominal input voltage		--	100	--	KHz
MTBF	MIL-HDBK-217F@25°C		3500	--	--	K hours

Mechanical Specifications

Case Material	Black Epoxy resin; flame-retardant and heat-resistant (UL94-V0)
Dimensions	12.70 x 11.20 x 7.25 mm
Weight	1.6g(Typ.)
Cooling Method	Free air convection

Electromagnetic Compatibility (EMC)

Emission	CE	CISPR32/EN55032 CLASS B (see Fig. 4 for recommended circuit)
	RE	CISPR32/EN55032 CLASS B (see Fig. 4 for recommended circuit)
Immunity	ESD	IEC/EN61000-4-2 Contact ±8KV perf. Criteria B

Typical Characteristic Curves

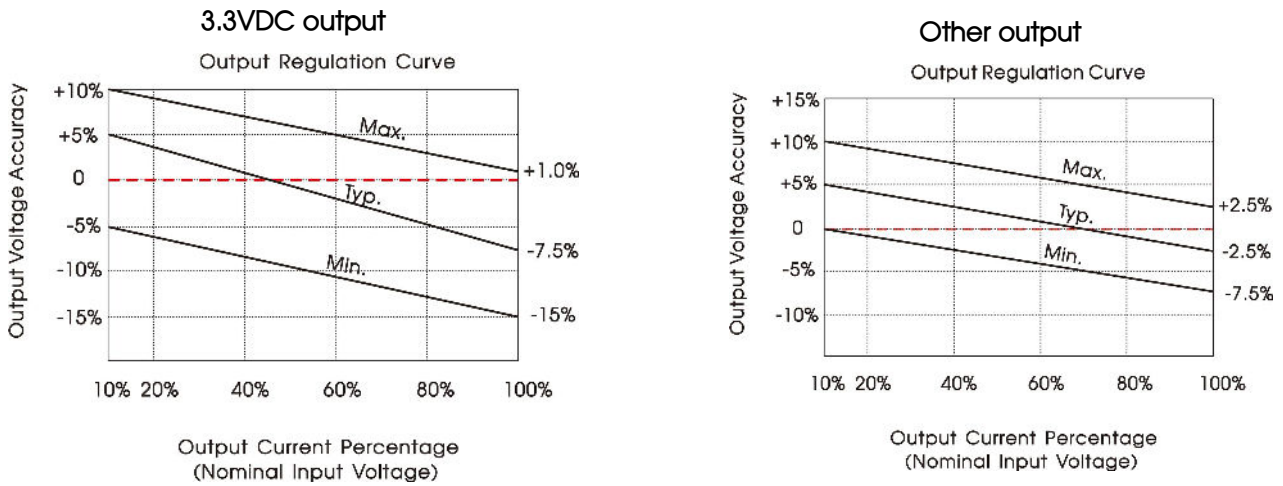

Fig. 1

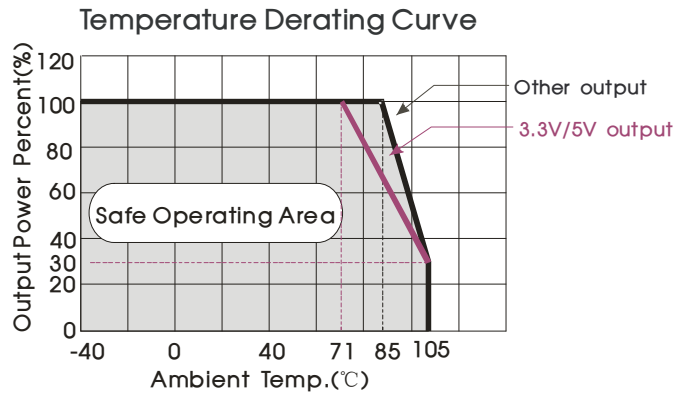
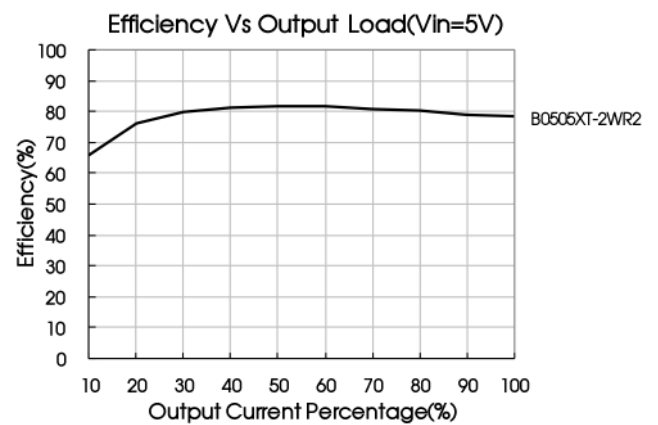
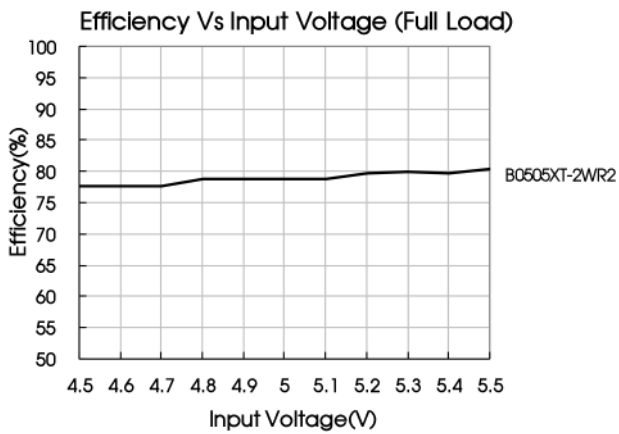
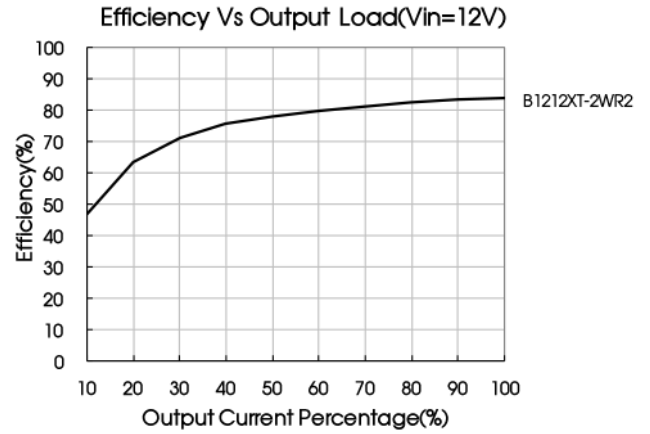
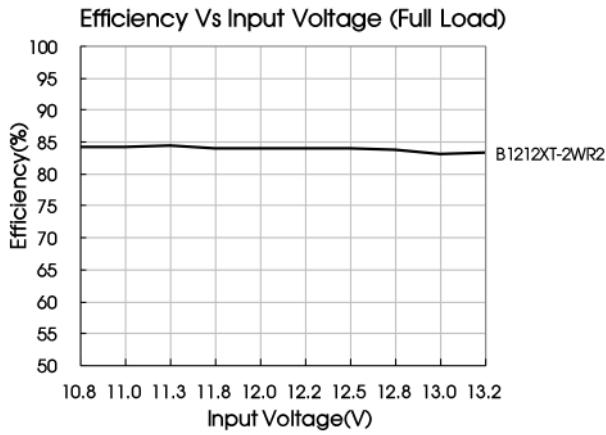

Fig. 2





Design Reference

1. Typical application

Input and/or output ripple can be further reduced, by connecting a filter capacitor from the input and/or output terminals to ground as shown in Fig.3.

Choosing suitable filter capacitor values is very important for a smooth operation of the modules, particularly to avoid start-up problems caused by capacitor values that are too high. For recommended input and output capacitor values refer to Table 1.

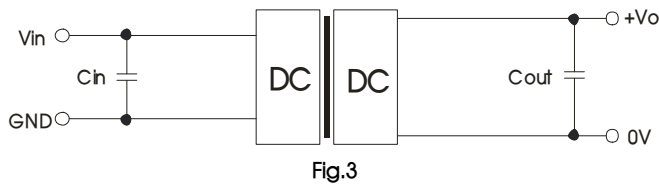
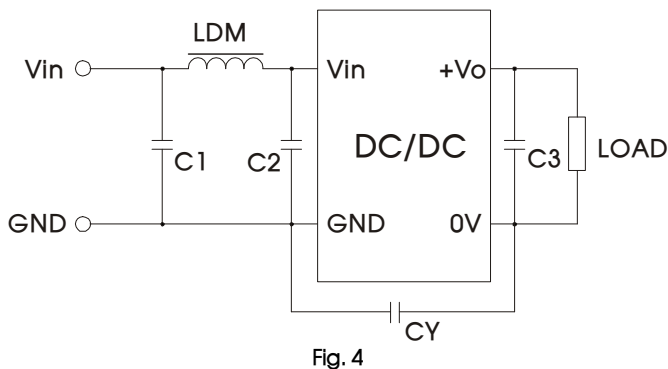

Table 1: Recommended input and output capacitor values

Vin (VDC)	Cin (μF)	Vo (VDC)	Cout (μF)
5	4.7	3.3	10
12	2.2	5	10
15	2.2	9	4.7
24	1	12	2.2
--	--	15	1
--	--	24	0.47

2. EMC (CLASS B) compliance circuit



Input voltage (VDC)		5/12/15	24
EMI	C1	4.7μF /50V	
	C2	4.7μF /50V	
	C3	Refer to the Cout in Fig.3	
	CY	--	1nF/2KV
	LDM	6.8μH	

Note: 1. For 24V input models use a Y-capacitor CY of 1nF/2kV.

3. Minimum Output Load Requirement

For a reliable and efficient operation of the converter, the minimum load should never be less than 10% of the rated output load. If the total required output power is below 10%, a parallel bleeding resistor is required on the output, ensuring that the sum of the power consumption is always maintained at 10% minimum.

4. For additional information, please refer to DC-DC converter application notes on www.mornsun-power.com

Dimensions and Recommended Layout

THIRD ANGLE PROJECTION 

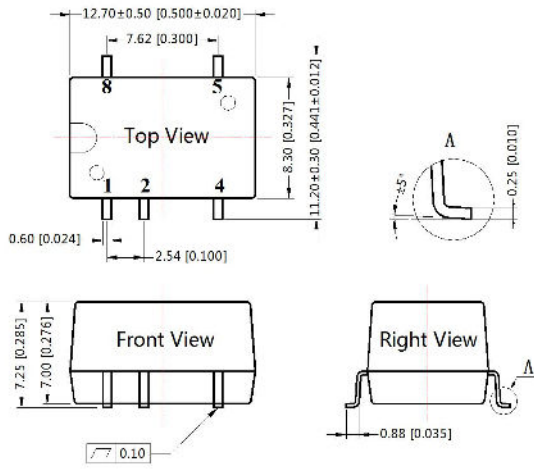

Note:
Unit: mm[inch]
Pin section tolerances: ± 0.10 [± 0.004]
General tolerances: ± 0.25 [± 0.010]

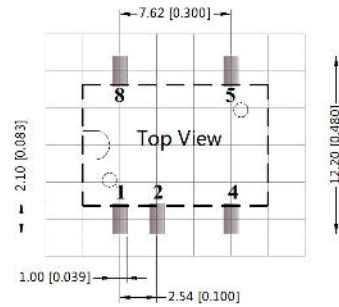

Note: Grid 2.54×2.54 mm

Pin-Out	
Pin	Function
1	GND
2	Vin
4	0V
5	+Vo
8	NC

NC: Pin to be isolated from circuitry

Notes:

- For additional information on Product Packaging please refer to www.mornsun-power.com. Packaging bag number: 58210024, Roll Packing bag number: 58200054;
- If the product is not operated within the required load range, the product performance cannot be guaranteed to comply with all parameters in the datasheet;
- The maximum capacitive load offered were tested at input voltage range and full load;
- Unless otherwise specified, parameters in this datasheet were measured under the conditions of $T_a = 25^\circ\text{C}$, humidity $< 75\% \text{RH}$ with nominal input voltage and rated output load;
- All index testing methods in this datasheet are based on our company corporate standards;
- We can provide product customization service, please contact our technicians directly for specific information;
- Products are related to laws and regulations: see "Features" and "EMC";
- Our products shall be classified according to ISO 14001 and related environmental laws and regulations, and shall be handled by qualified units.

MORNSUN Guangzhou Science & Technology Co., Ltd.

Address: No. 5, Kehui St. 1, Kehui Development Center, Science Ave., Guangzhou Science City, Huangpu District, Guangzhou, P. R. China
Tel: 86-20-38601850 Fax: 86-20-38601272 E-mail: info@mornsun.cn www.mornsun-power.com